

**Absolute single-/multi-turn encoder TRT/S3
with PROFIsafe over PROFINET interface**
Relevant data sheet TRT 12845

SUPREME SENSING
TWK

Document no.: TRT 12846 NE
Date: 20.02.2020



SIL2 FUNCTIONAL
IEC 61508 SAFETY
SENSOR



User manual

Translation of the original instructions

COPYRIGHT: The Operating Instructions TRT 12846
is owned by TWK-ELEKTRONIK GMBH and is
protected by copyright laws and international treaty provisions.

© 2020 by TWK-ELEKTRONIK GMBH
POB 10 50 63 ■ 40041 Düsseldorf ■ Germany
Tel. +49/211/96 11 70 ■ Fax +49/211/63 77 05
info@twk.de ■ www.twk.de

Table of contents

Table of contents

1. Safety instructions	6
1.1 Scope.....	6
1.2 Documentation.....	6
1.3 Proper use	6
1.4 Commissioning	6
2. General information	7
3. Installation.....	8
3.1 General information	8
3.2 Electrical connection	8
3.3 Status LEDs	9
3.4 Project planning	9
4. Project planning with Simatic Step7.....	10
4.1 Step7, Distributed Safety - Simatic Manager	10
4.1.1 Prerequisites	10
4.1.2 Installation of the GSD file	10
4.1.3 Installing the absolute encoder	11
4.1.4 Install module.....	12
4.1.5 Setting the network data (properties TRT/S3)	14
4.1.6 Setting the absolute encoder (properties of the module).....	15
4.1.6.1 Setting the I/O address	15
4.1.6.2 Parameterising the absolute encoder	15
4.1.6.3 Setting the F parameters	16
4.1.7 Setting real time mode and the updating time	17
4.1.8 Planning of "Device exchange without programming device" and "Automatic commissioning" ...	17
4.1.9 Assignment of the device name	18
4.1.10 Resetting to the default settings	19
4.2 Step7, Safety Advance - TIA-Portal.....	20
4.2.1 Prerequisites	20
4.2.2 Installation of the GSD file	20
4.2.3 Installing the absolute encoder	21
4.2.4 Install module.....	22
4.2.5 Setting the network data	23
4.2.5.1 Setting the PROFINET / PROFIsafe Adresse.....	23

Table of contents

4.2.5.2 IP-Adresse	24
4.2.5.3 Prioritized startup, media redundancy, update time and synchronisation.....	24
4.2.6 Setting the absolute encoder (properties of the module).....	24
4.2.6.1 Setting the I/O address	24
4.2.6.2 Parameterising the absolute encoder	25
4.2.6.3 Setting the F parameters	25
4.2.7 Planning of "Device exchange without programming device" and "Automatic commissioning" ...	26
4.2.8 Assignment of the device name	27
4.2.9 Resetting to the factory settings	28
4.3 Application program	29
4.3.1 Remarks.....	29
4.3.2 F-Peripherie-DB	29
4.3.3 Accessing the encoder in the F program	29
4.3.4 Example program.....	30
5. I/O data	39
5.1 Overview	39
5.1.1 Output code R and W	39
5.1.2 Output code D.....	39
5.3 Position data	39
5.3.1 Data format coding R	40
5.3.2. Data format coding W	40
5.3.3 Data format coding D	40
5.4 Velocity	40
5.5 F input data.....	41
5.6 Control word	41
5.7 Preset value (reference value).....	41
5.7.1 Data format coding R	42
5.7.2. Data format coding W	42
5.7.3 Data format coding D	42
5.8 F output data.....	42
6. Parameterisation	43
6.1 Encoder parameter	43
6.1.1 Overview	43
6.1.2 Description of the absolute encoder parameters	43
6.2 F parameter	44
6.2.1 Overview	44
6.2.2 Description of the F parameters.....	44

Table of contents

7. Diagnostic	46
7.1 Overview	46
7.2 PROFINET alarms	46
7.3 Diagnostic data records	47
7.3.1 Diagnostic data according to Encoder Class 2 Profile	47
8. Scope of delivery	49
9. Literature	49

Safety instructions

1. Safety instructions

1.1 Scope

This user manual is valid exclusively for the following absolute encoders with PROFINET interface:

- TRTxx-xxxxxxxR4096S3xTxx(Multiturn)
- TRTxx-xxxxxxxS3xTx (Singleturn)

1.2 Documentation

The following documents must be observed:

- The owner's system-specific operating instructions
- This user manual
- Data sheet number TRT 12845
- The connection assignment enclosed with the device
- Assembly instructions TZY10206 enclosed with the device

1.3 Proper use

The TWK-ELEKTRONIK GmbH absolute encoders and linear transducers are used to register angular or linear positions and make their measured value available in the form of an electrical output signal. As part of a system, they have to be connected to the downstream electronics and must only be used for this purpose.

1.4 Commissioning

- The relevant device may only be set up and operated in combination with this and the documentation specified under point 1.2.
- Protect the device against mechanical damage during installation and operation.
- Device commissioning and operation may only be undertaken by a specialist electrician.
- Do not operate the device outside of the limit values specified in the data sheet.
- Check all electrical connections before commissioning the system.

General information

Installation

3. Installation

3.1 General information

- During installation, observe the profinet assembly guideline PNO order No.: 8.071
- Use only certified profinet cables, connectors and switches (see "PROFINET Cabling and Interconnection Technology" PNO order No.: 2.252 and "Installation Guideline PROFINET Part 2: Network Components" PNO order No.: 2.252 p2)
- Hubs are not permissible.
- The cable length between two subscribers may be max. 100 m.
- The TWK TRT absolute encoder possesses an integrated switch. This not only enables tree and star topologies but also the linear topology.
- Media redundancy protocol support enables the establishment of a redundant ring.
- The setting of addresses, the baud rate or terminating resistors on the device is not necessary.

3.2 Electrical connection

The "...MT01" type absolute encoders have separate connectors for the supply and the PROFINET system. Port 1 or port 2 are optionally available for the PROFINET connection. Due to the integrated switch, it is irrelevant which port is used.

Connection	Designation	Connector type
PROFINET	Port 1	M12x4 D-coded socket
PROFINET	Port 2	M12x4 D-coded socket
Voltage supply	24 VDC	M12x4 A-coded pins

Refer to data sheet No. 12886 for connector assignment and ordering information.

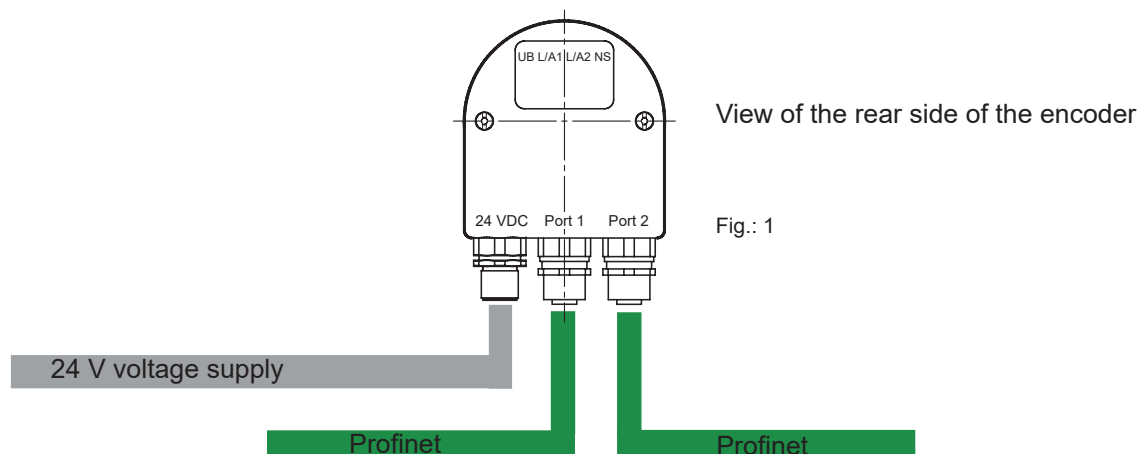

Installation

3.3 Status LEDs

Four LEDs are housed in the absolute encoder's connecting cap. These have the following meaning:

UB (VS)	Link 1 (L1)	Link 2 (L2)	Status (NS)	Description
green	green	green	green/red	
on				Operating voltage available
	on			Network connection established
		on		Network connection established
			green	Data exchange, device in operation and OK
			green flashing	Network connection o.k. but no connection to a PROFINET controller
			red, slow flashing	Firmware download mode
			red flashing	Impermissible parameter or preset value, velocity too high or wrong module
			Fast red flashing	Device error
			red	Connection to the PROFINET controller disrupted

In [Chapter 7](#) diagnosis you can find all diagnosis data of the TRT/S3.

Flashing codes

Errors which lead to encoder system standstill (hard errors) are indicated by a flashing code on the part of the red NS LED. Following introductory flickering by the red LED, a specific number of flashing cycles are output for the cause of the error.

	Number of flashing cycles (Duration approx. 1 s)	Error cause
Flashing code 1	1	F stack error
Flashing code 2	2	CRC error ROM
Flashing code 3	3	RAM/XRAM error
Flashing code 5	5	Programme sequence error
Flashing code 6	6	Power consumption too high

3.4 Project planning

A device description file (GSD file) in the XML format GSDML and an image (bitmap) to integrate the absolute encoder into a project planning tool are available in the internet under www.twk.de

File name of the GSD file: GSDML-V2.3-TWK-TRTS3-20171122.xml (The version and date may vary depending on the status of the GSD file.)

File name of the bitmap: GSDML-0159-6300-TWK_TRTS.bmp

Project planning using the example of Step7 is explained in the following chapter.

Project planning with Simatic Step7, Distributed Safety - Simatic Manager

4. Project planning with Simatic Step7

4.1 Step7, Distributed Safety - Simatic Manager

This chapter explains the procedure for integrating the TWK TRT/S3 absolute encoder into the PROFINET network of a Siemens S7 control system with Step7 version 5.5. and Distributed Safety version 5.4

4.1.1 Prerequisites

You have created a hardware configuration in accordance with your control system structure and a PROFINET sub-network.

This is shown here using the example of a CPU314C:

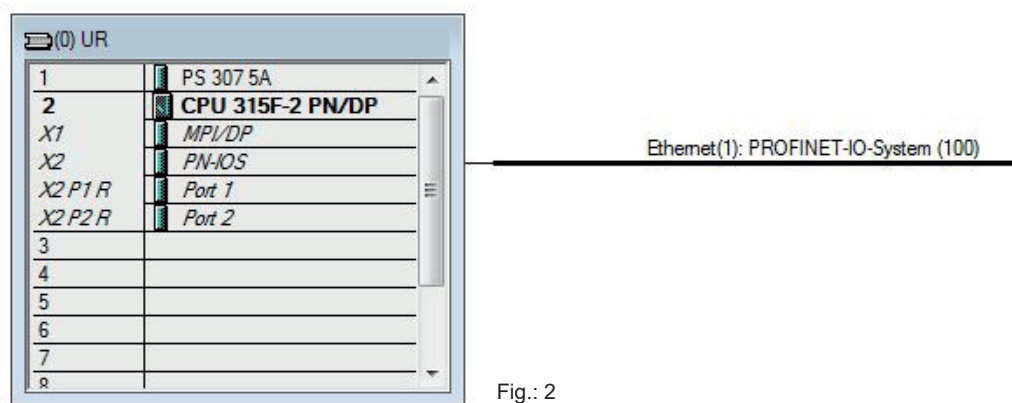

Fig.: 2

4.1.2 Installation of the GSD file

- Under Extras in the hardware configuration, select **Install GSD files**.
- Set "from the directory", "browse" to your GSD file and click on "Install" (see Figure 3).
- The absolute encoder symbol is also installed automatically, provided that it is in the same directory

Note: The GSD file and the encoder symbol are available for download under www.twk.de.

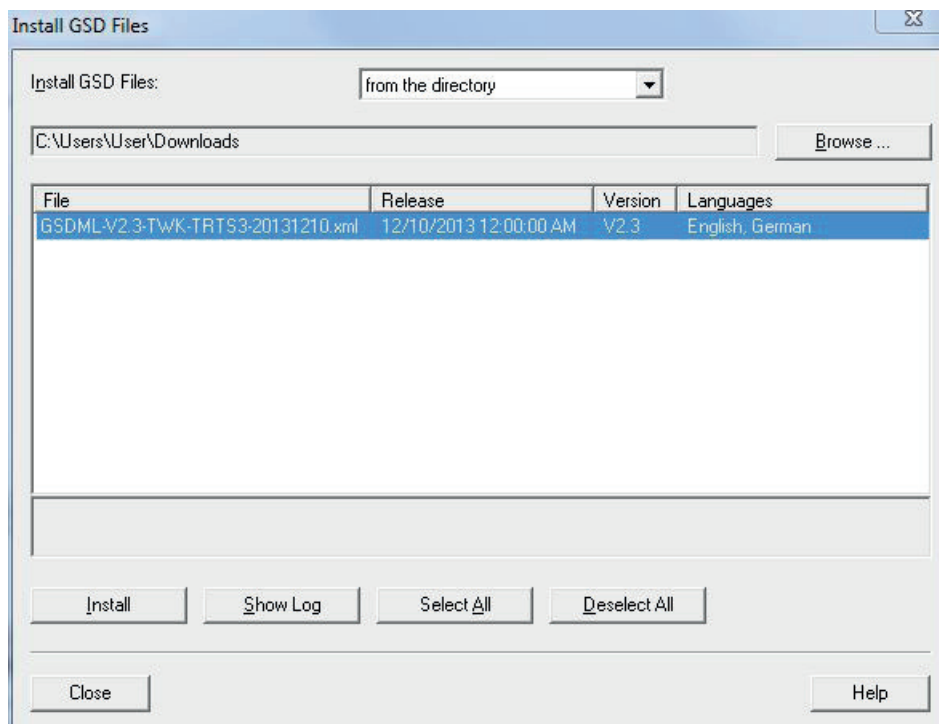

Fig.: 3

Project planning with Simatic Step7, Distributed Safety - Simatic Manager

After installing the GSD file, the hardware catalogue is automatically updated. The TRT absolute encoder is located under **PROFINET, Further FIELD DEVICES, Encoders, TWK T series, TRT/S**.

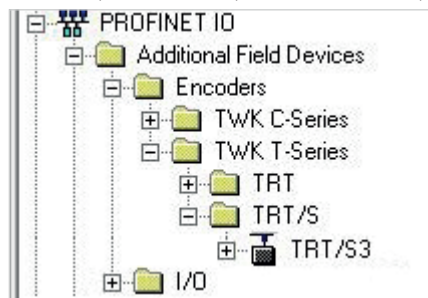

Fig.: 4

4.1.3 Installing the absolute encoder

Now drag the TRT encoder onto your PROFINET system using the mouse.

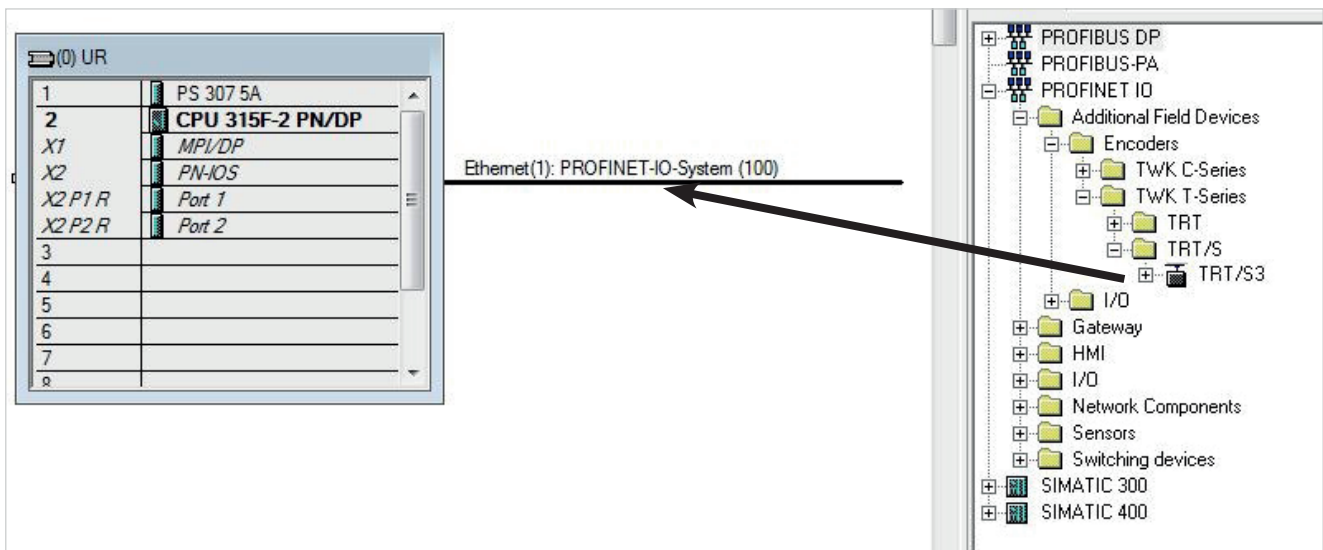

Fig.: 5

The absolute encoder's PROFINET interface is then installed together with its default values. The module corresponding to the absolute encoder then has to be installed.

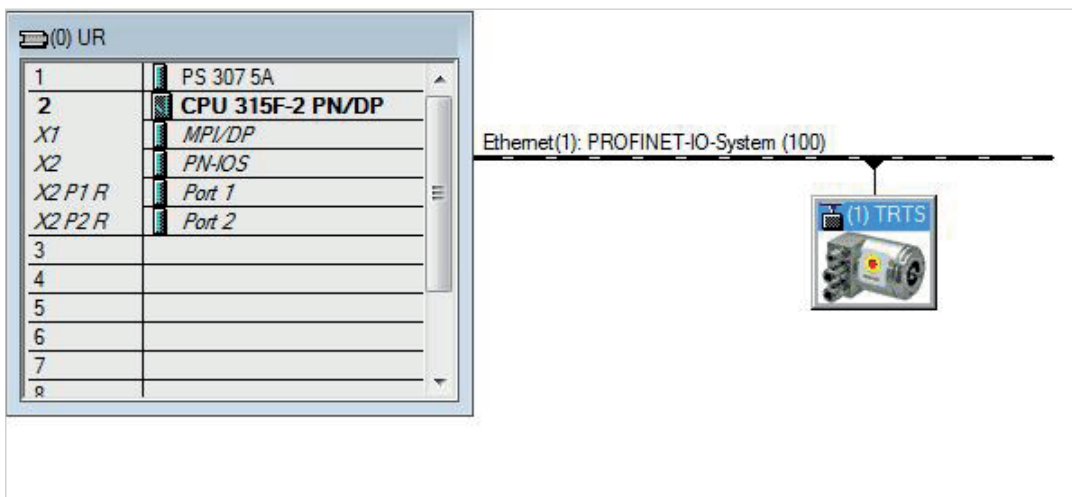

Fig.: 6

Project planning with Simatic Step7, Distributed Safety - Simatic Manager

4.1.4 Install module

For the encoder TRT there are modules with different resolutions and data formats available. The module to be used is defined by the encoder type. Singlturn encoders and 14 bit resolution are available from HW version 2. With these, it is also possible to add another unsafe module to slot 2. The unsafe module has only input data to which the data of the safe module is mirrored.

Module	Resolution	Multiturn	Functionality
TRTxx-xxx 4096R4096S3xTx	12 bit	x	Safe position (2x integer16), safe speed, preset
TRTxx-xxx 4096W4096S3xTx	12 bit	x	Safe position (2x integer16, separated single and multiturn data), safe speed, preset
TRTxx-xxx 4096D4096S3xTx	12 bit	x	Safe position (1x integer32), safe speed, preset (module not useable in Distributed Safety)
TRTxx-xxx 8192R4096S3xTx	13 bit	x	Safe position (2x integer16), safe speed, preset
TRTxx-xxx 8192W4096S3xTx	13 bit	x	Safe position (2x integer16, separated single and multiturn data), safe speed, preset
TRTxx-xxx 8192D4096S3xTx	13 bit	x	Safe position (1x integer32), safe speed, preset (module not useable in Distributed Safety)
Available from HW version 2			
TRTxx-xxx 16384RS3xTx	14 Bit		Safe position (2x integer16), safe speed, preset
TRTxx-xxx 16384RS3xTx-unsafe	14 Bit		Position (2x integer16), safe speed
TRTxx-xxx 16384DS3xTx	14 Bit		Safe position (1x integer32), safe speed, preset (module not useable in Distributed Safety)
TRTxx-xxx 16384DS3xTx-unsafe	14 Bit		Position (1x integer32), speed (module not useable in Distributed Safety)
TRTxx-xxx 16384R4096S3xTx	14 Bit	x	Safe position (2x integer16), safe speed, preset
TRTxx-xxx 16384R4096S3xTx-unsafe	14 Bit	x	Position (2x integer16), speed
TRTxx-xxx 16384W4096S3xTx	14 Bit	x	Safe position (2x integer16, separated single and multiturn data), safe speed, preset
TRTxx-xxx 16384W4096S3xTx-unsafe	14 Bit	x	Position (2x integer16, separated single and multiturn data), speed
TRTxx-xxx 16384D4096S3xTx	14 Bit	x	Safe position (1x integer32), safe speed, preset (module not useable in Distributed Safety)
TRTxx-xxx 16384D4096S3xTx-unsafe	14 Bit	x	Position (1x integer32), speed (module not useable in Distributed Safety)

Project planning with Simatic Step7, Distributed Safety - Simatic Manager

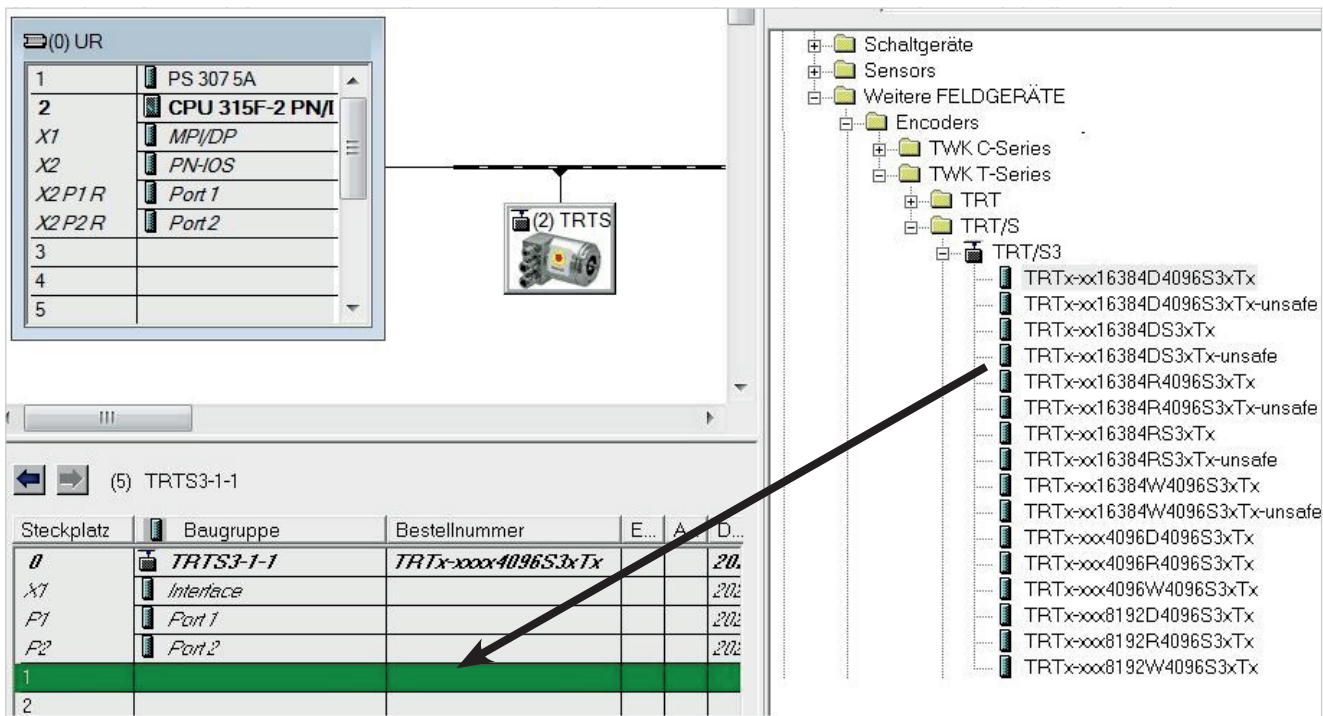

Fig.: 7

The network data can be set by double-clicking onto the absolute encoder symbol (see [Chapter 4.1.5](#)), and the I/O address plus the absolute encoder parameters can be set by double-clicking onto the line "Slot 1" (see [Chapter 4.1.6](#)).

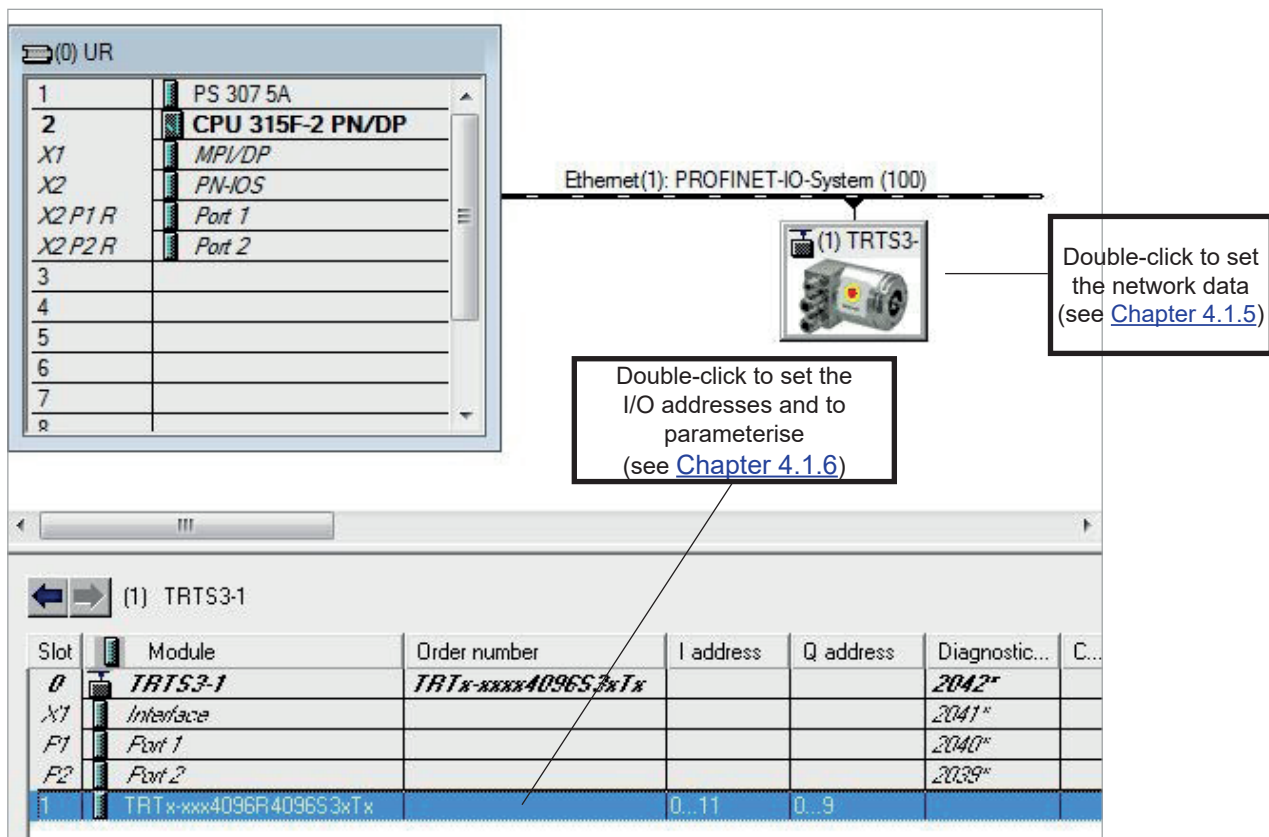

Fig.: 8

Project planning with Simatic Step7, Distributed Safety - Simatic Manager

4.1.5 Setting the network data (properties TRT/S3)

The following dialogue appears by double-clicking onto the absolute encoder symbol (or via the absolute encoder's context menu). Enter a name which is unique throughout the network to identify the device here. The controller expects this name when the device logs in. The default name is TRTS3-1.

In the TRT/S3, the **Profisafe address** must be added to the name. To do this, attach a number between 1 and 65,535 to the end (a special separator between the Profinet name and Profisafe address is not necessary). This must then be entered for F_Dest_Add under the F parameters (see [Chapter 4.1.6.3](#)).

The name assigned here must either be manually allocated to the absolute encoder (see [Chapter 4.1.9](#)) or it can be assigned automatically by the controller using the topology editor (see [Chapter 4.1.8](#) Planning of "Device exchange without programming device" and "Automatic commissioning").

The device name is stored in the absolute encoder, where it is protected against zero voltage. An installed device can be exchanged with a brand new device without a programming device or exchanging a memory card. The correct name is automatically assigned to the new absolute encoder by the controller. To do this, however, the prerequisites under [Chapter 4.1.8](#) have to be met.

If the tick in front of "IP address assignment by IO controller" is set, the controller automatically assigns an IP address to the device which contacts it with this name. Manually setting an address as is usual in the case of previous field bus systems is not necessary.

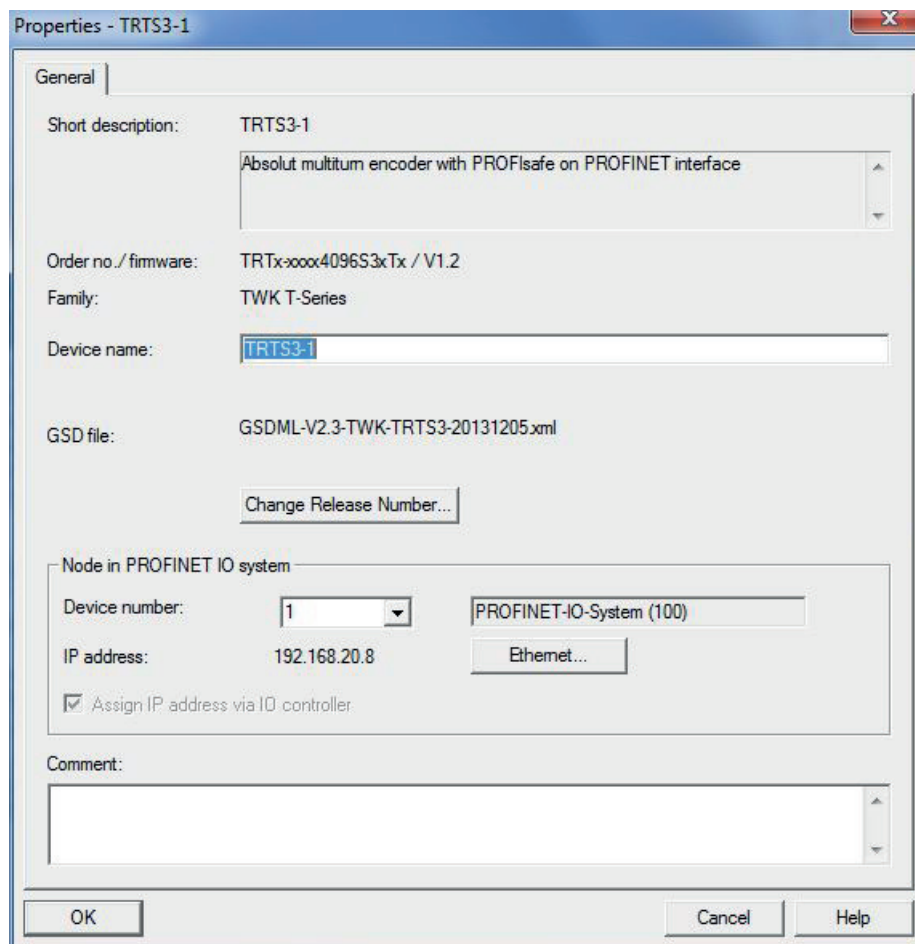

Fig.: 9

Project planning with Simatic Step7, Distributed Safety - Simatic Manager

4.1.6 Setting the absolute encoder (properties of the module)

4.1.6.1 Setting the I/O address

The dialogues for setting the I/O address and for setting the absolute encoder parameters and F-Parameters can be accessed by double-clicking the installed module (slot 1 line) or via the module's context menu.

Set the address for the input data position, velocity and status and the address for the output data control and preset in the "Addresses" tab. (See [Chapter 5](#) for the data format).

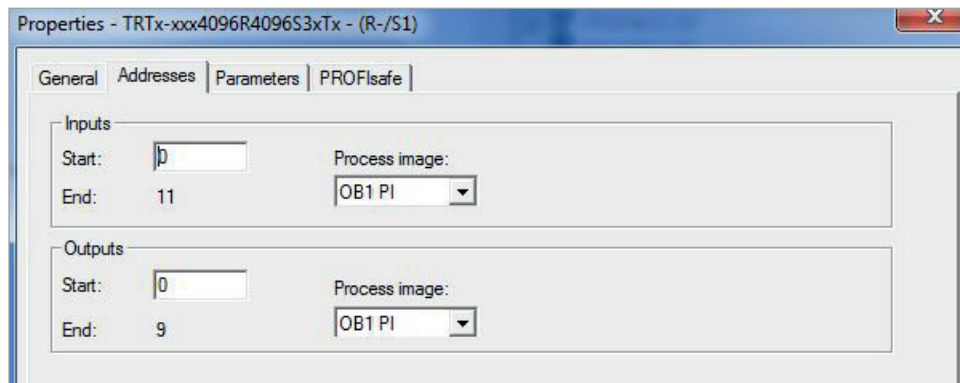

Fig.: 10

4.1.6.2 Parameterising the absolute encoder

The absolute encoder's parameters can be changed in the "Parameters" tab. An explanation of the parameters can be found in [Chapter 6](#). After changing the encoder parameters the checksum has to be re-calculated and entered under the F-parameters (see next chapter).

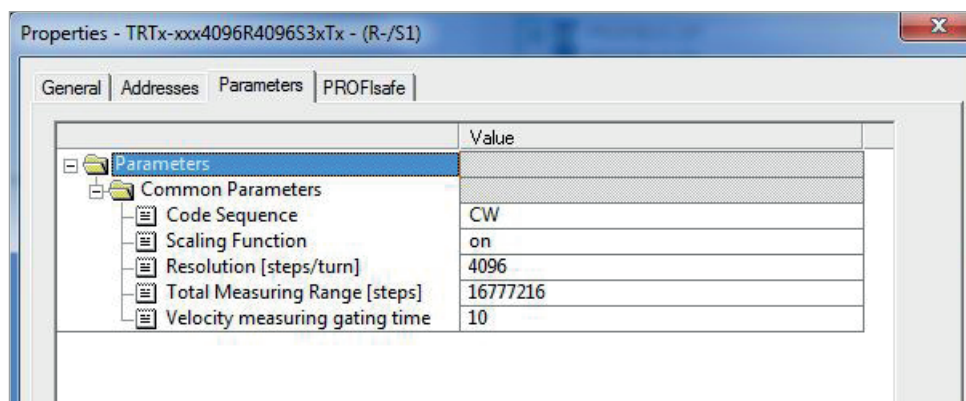

Fig.: 11

Project planning with Simatic Step7, Distributed Safety - Simatic Manager

4.1.6.3 Setting the F parameters

The F parameters must be set in the "PROFIsafe" tab. Here, the Profisafe address attached to the Profinet name must be set under "F_Dest_Add" and a watchdog time corresponding to your system must be specified under "F_WD_Time". "F_Source_Add" is assigned automatically by the S7

Once you have changed the rotary encoder parameters, the checksum must be recalculated using these so-called i parameters and must be entered under "F_iPar_CRC". TWK provides you with the PsCRC programme for calculating the F_iPar_CRC (see Fig. 12).

An explanation of all F parameters can be found in [Chapter 6.2](#).

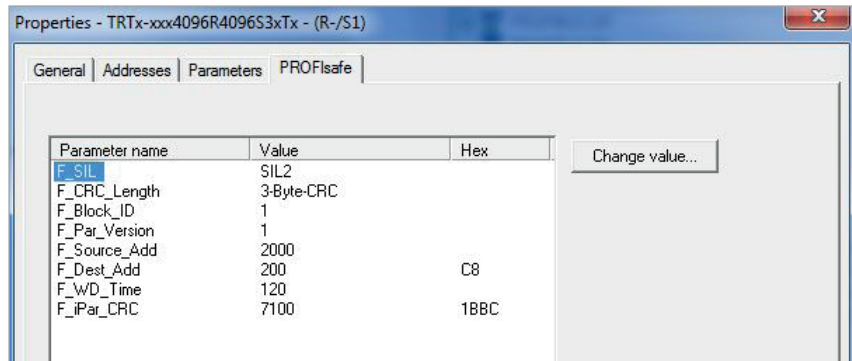

Fig.: 12

The PsCRC programme for calculating the F_iPar_CRC is available for downloading in the Internet under www.twk.de, documentation area, PsCRC

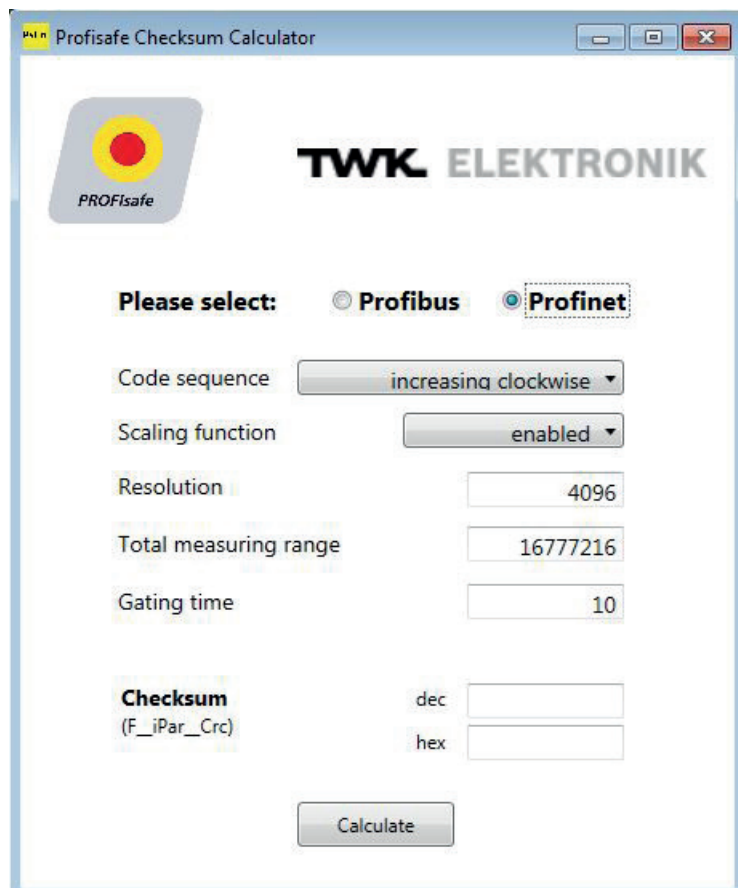

Fig.: 13

Project planning with Simatic Step7, Distributed Safety - Simatic Manager

4.1.7 Setting real time mode and the updating time

The following dialogues are accessed via the PROFINET system's context menu:

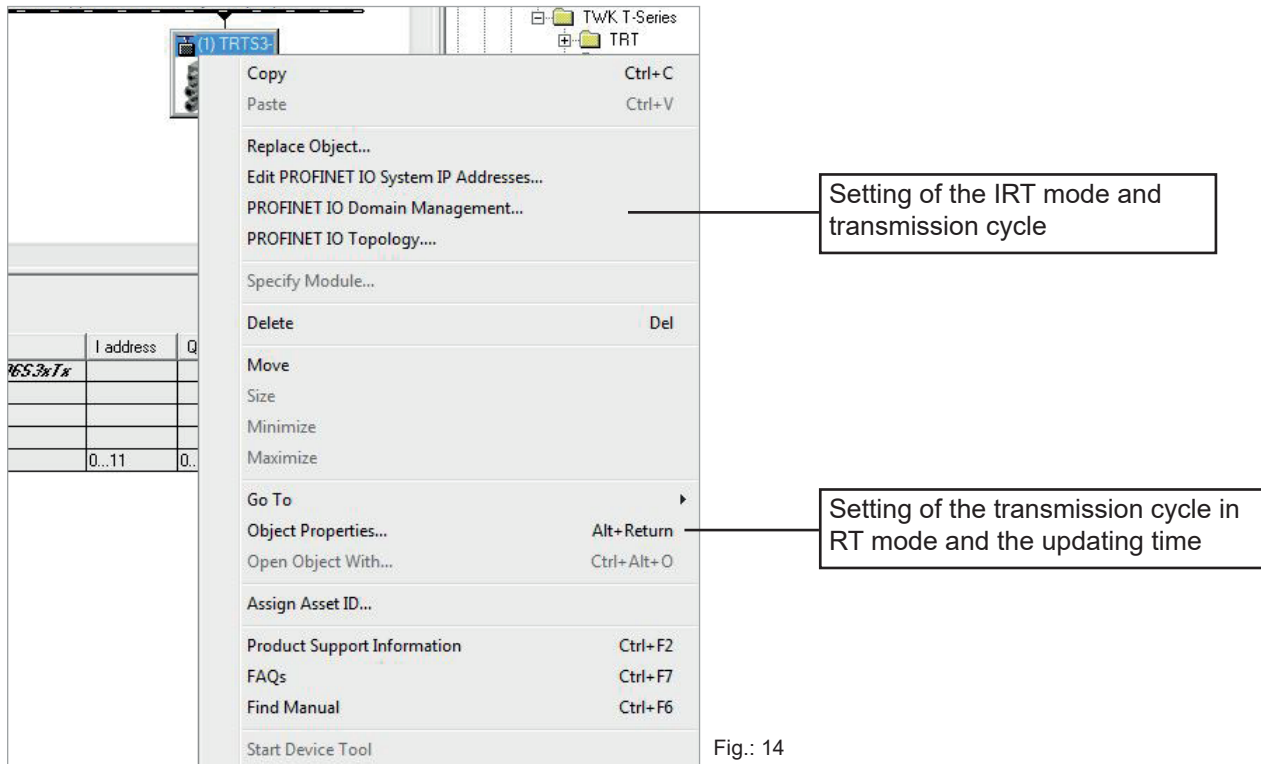

Fig.: 14

Set the transmission cycle and the desired updating time in the corresponding dialogue. Alternatively, the updating time can also be set via the interface's object properties. The default value is 2 ms for the updating time and 1 ms for the transmission cycle. The minimum updating time for the TRT/3 is 250 µs.

4.1.8 Planning of "Device exchange without programming device" and "Automatic commissioning"

If system restarting without the assignment of a new device name or the IP address is to be possible following the exchange of an installed absolute encoder with a mint condition device, this must be taken into consideration during project planning. This also applies to "Automatic commissioning", in which the manual and, in the case of larger projects, time-consuming assignment of the device name (as described in [Chapter 4.1.9](#)) is avoided during commissioning.

The following prerequisites have to be met:

- The controller and the devices must support the function "Device exchange without interchangeable medium or programming device" (for the latter, at least the device itself and its neighbouring devices). The TRT/S3 supports this function.
- The function "Device exchange without interchangeable medium" must be activated in the controller. This is the default setting.
- The devices must be in delivery condition, i.e. they must not yet possess any device name.

Now call the topology editor using the PROFINET system's context menu (see Fig. 12) and define all PROFINET connections between the subscribers.

If the project is now loaded into the control system and the actual structure corresponds to the planned topology, all subscribers receive their planned names from the controller and device exchange succeeds without the reassignment of the device name.

Project planning with Simatic Step7, Distributed Safety - Simatic Manager

4.1.9 Assignment of the device name

If a PROFINET topology has not been defined as described in [Chapter 4.1.8](#) or if the prerequisites for automatic commissioning are not met, the absolute encoder name must be assigned manually.

With the absolute encoder connected and the programming device connected to the control system, select "Target system -> Edit Ethernet subscribers" in the Simatic Manager to do this. Press the "Browse" button in the subsequent dialogue. All accessible PROFINET subscribers should now be shown as portrayed in the example in Figure 15.

It can be seen that the absolute encoder device type "TWK T series" does not possess either a valid IP address or a name. Now mark the absolute encoder and exit the dialogue with OK.

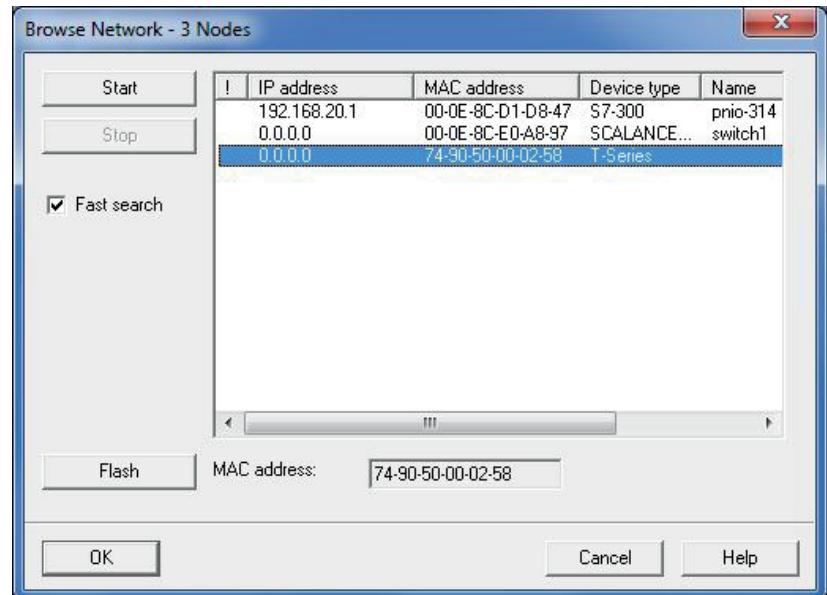

Fig.: 15

In the subsequent dialogue, enter the device name, that who have assigned for this encoder in the project planning (see [Chapter 4.1.5](#)) and click onto the "Assign name" button. The device name is then stored in the absolute encoder, where it is protected against zero voltage.

The absolute encoder now logs onto the controller with its device name and is then provided with a valid IP address by the controller. This is also stored in the absolute encoder, where it is protected against zero voltage.

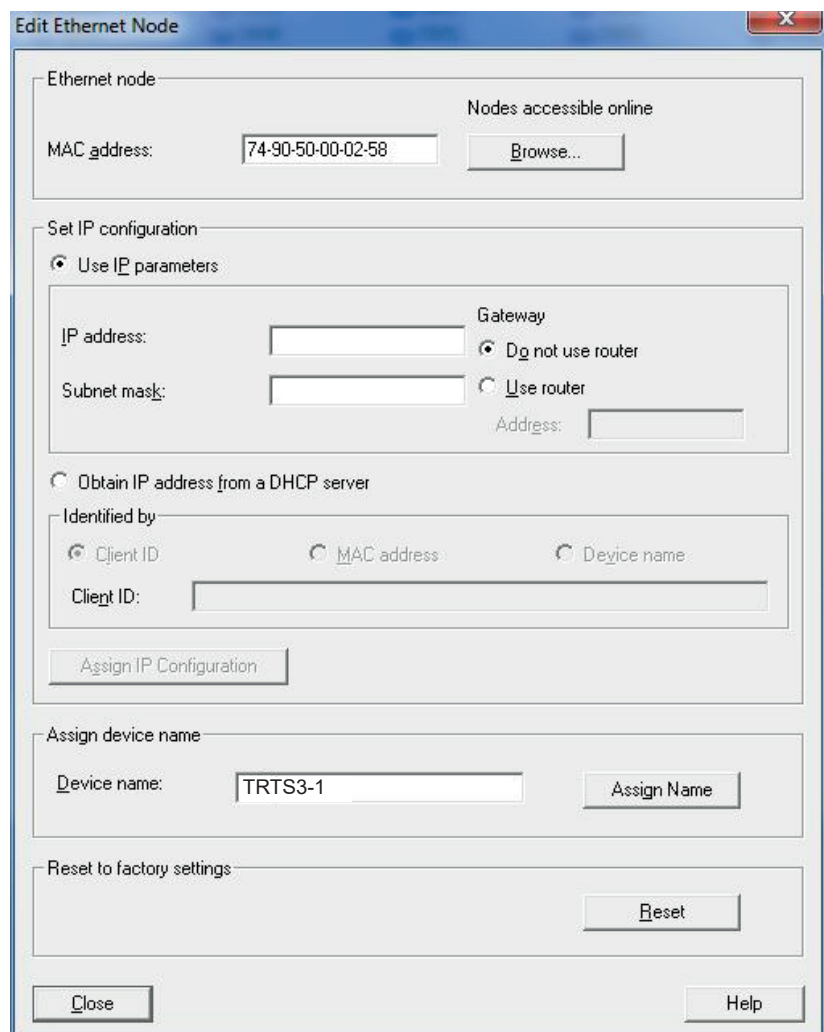

Fig.: 16

Project planning with Simatic Step7, Distributed Safety - Simatic Manager

4.1.10 Resetting to the default settings

The absolute encoder can be reset to its delivery condition using the "Reset" button in the "Edit Ethernet subscribers" dialogue (Figure 16).

The following are reset	Delivery condition
Device name	Empty
IP-parameters	All 0
I&M0-revision counter	0

After resetting, the connection to the profinet controller is closed and the NS LED lights up red. After switching the voltage off/on, the connection can be re-established by assigning the device name.

If the connections have been defined using the topology editor, the TRT/S3 restarts automatically with the name assigned during project planning.

Project planning with Simatic Step7, Advanced Safety - TIA Portal

4.2 Step7, Safety Advance - TIA-Portal

This chapter explains the procedure for integrating the TWK TRT/S3 absolute encoder into the PROFINET network of a Siemens S7 control system with Step 7 Professional V13 with Safety Advanced.

4.2.1 Prerequisites

You have created a hardware configuration in accordance with your control system structure and a PROFINET sub-network.

This is shown here using the example of a CPU314C:

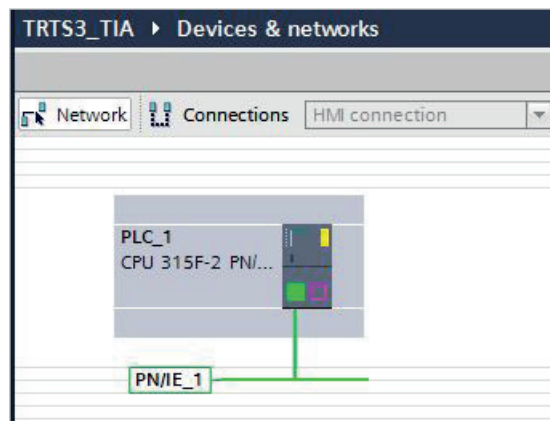

Fig.: 17

4.2.2 Installation of the GSD file

- In the main menu choose **Options, Install general station description file (GSD)**.
- Set the source path to your GSD file, check the GSD file and click on "Install" (see Figure 3).
- The absolute encoder symbol is also installed automatically, provided that it is in the same directory

Note: The GSD file and the encoder symbol (bitmap) are available for download under www.twk.de.

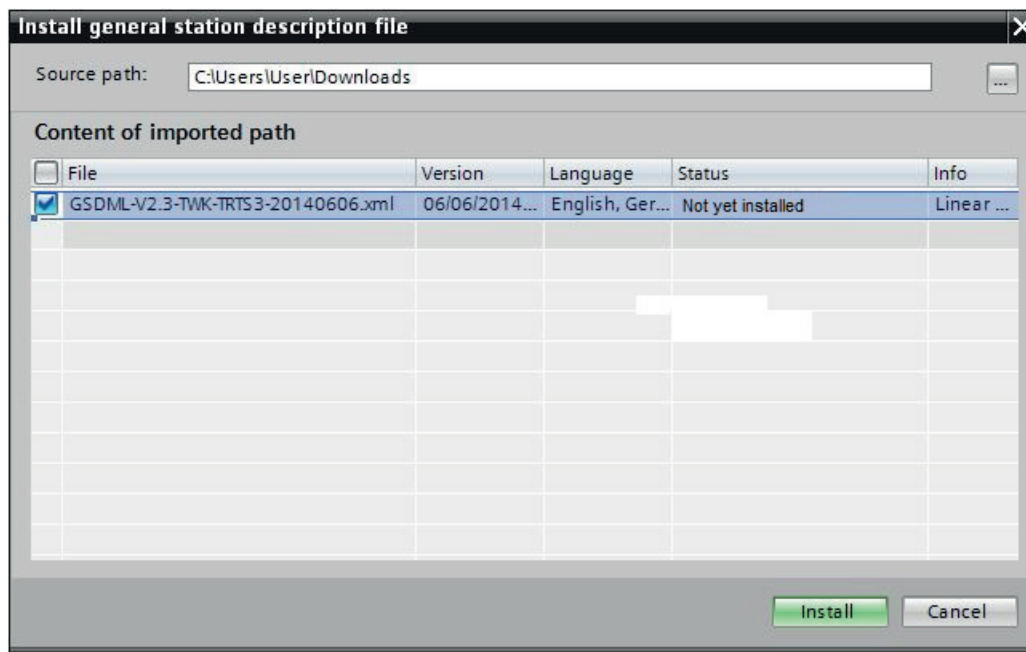

Fig.: 18

Project planning with Simatic Step7, Advanced Safety - TIA Portal

After installing the GSD file, the hardware catalogue is automatically updated. The TRT absolute encoder is located under **Further FIELD DEVICES, PROFINET IO, Encoders, TWK-ELEKTRONIK GmbH, TWK T series, TRT/S**.

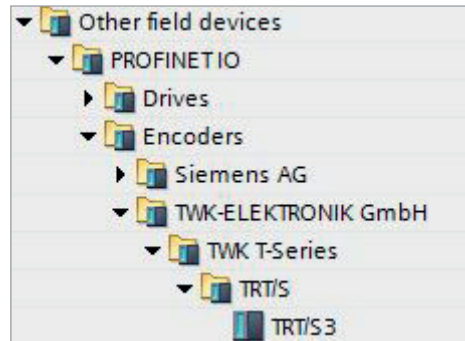

Fig.: 19

4.2.3 Installing the absolute encoder

Now drag the TRT/S3 encoder from the hardware catalogue in the netview of your project.

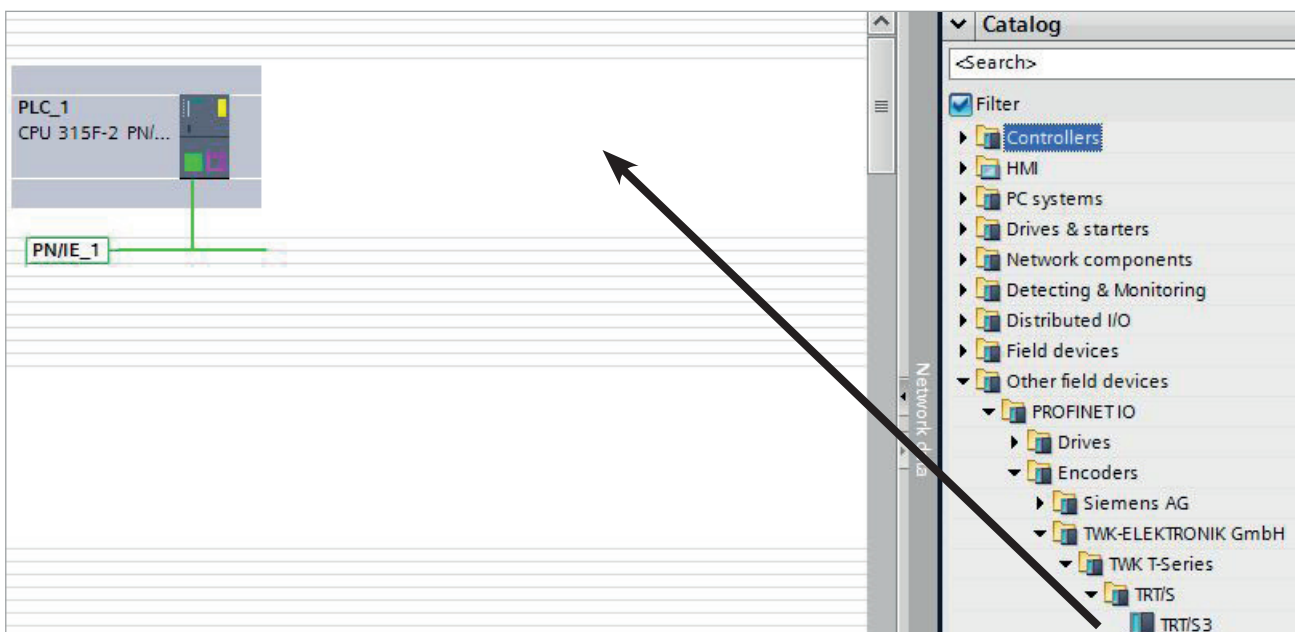

Fig.: 20

Afterwards click on "Not assigned" and assign the encoder to the PROFINET interface of your CPU or draw a network connection from the encoder to the CPU port with your mouse.

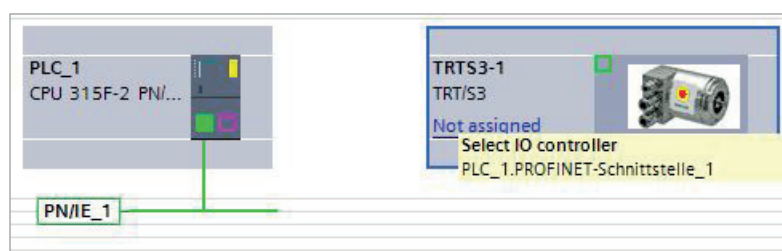

Fig.: 21

The encoder's PROFINET-Interface is now installed with its default values.

Project planning with Simatic Step7, Advanced Safety - TIA Portal

4.2.4 Install module

To install the encoder module change to the **Device view** and drag the module corresponding to you encoder to the first free slot of the module list.

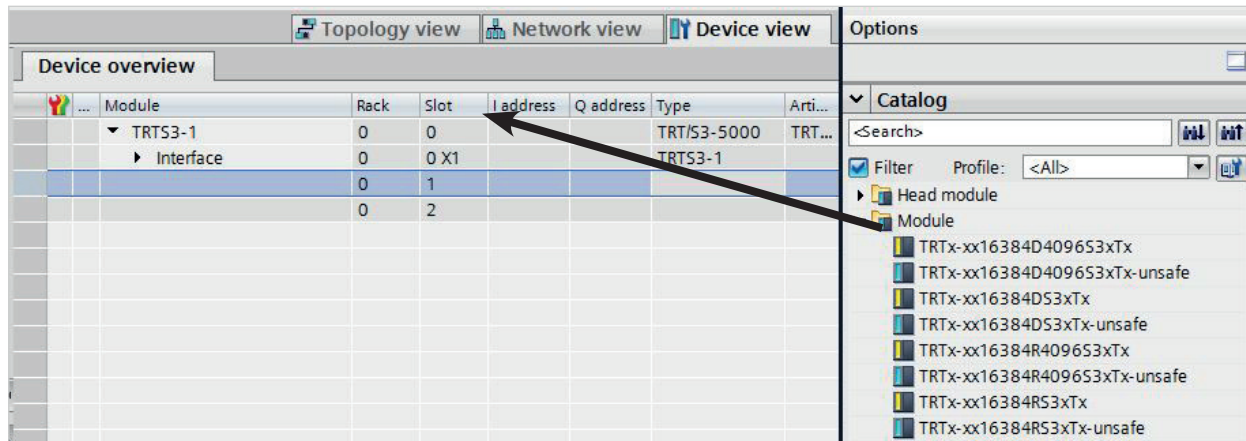

Fig.: 22

For the encoder TRT there are modules with different resolutions and data formats available. The module to be used is defined by the encoder type. Singlturn encoders and 14 bit resolution are available from HW version 2. With these, it is also possible to add another unsafe module to slot 2. The unsafe module has only input data to which the data of the safe module is mirrored.

Module	Resolution	Multiturn	Functionality
TRTxx-xxx 4096R4096S3xTx	12 bit	x	Safe position (2x integer16), safe speed, preset
TRTxx-xxx 4096W4096S3xTx	12 bit	x	Safe position (2x integer16, separated single and multiturn data), safe speed, preset
TRTxx-xxx 4096D4096S3xTx	12 bit	x	Safe position (1x integer32), safe speed, preset (module not useable in Distributed Safety)
TRTxx-xxx 8192R4096S3xTx	13 bit	x	Safe position (2x integer16), safe speed, preset
TRTxx-xxx 8192W4096S3xTx	13 bit	x	Safe position (2x integer16, separated single and multiturn data), safe speed, preset
TRTxx-xxx 8192D4096S3xTx	13 bit	x	Safe position (1x integer32), safe speed, preset (module not useable in Distributed Safety)
Available from HW version 2			
TRTxx-xxx 16384RS3xTx	14 Bit		Safe position (2x integer16), safe speed, preset
TRTxx-xxx 16384RS3xTx-unsafe	14 Bit		Position (2x integer16), safe speed
TRTxx-xxx 16384DS3xTx	14 Bit		Safe position (1x integer32), safe speed, preset (module not useable in Distributed Safety)
TRTxx-xxx 16384DS3xTx-unsafe	14 Bit		Position (1x integer32), speed (module not useable in Distributed Safety)

Project planning with Simatic Step7, Advanced Safety - TIA Portal

TRTxx-xxx 16384R4096S3xTx	14 Bit	x	Safe position (2x integer16), safe speed, preset
TRTxx-xxx 16384R4096S3xTx-unsafe	14 Bit	x	Position (2x integer16), speed
TRTxx-xxx 16384W4096S3xTx	14 Bit	x	Safe position (2x integer16, separated single and multiturn data), safe speed, preset
TRTxx-xxx 16384W4096S3xTx-unsafe	14 Bit	x	Position (2x integer16, separated single and multiturn data), speed
TRTxx-xxx 16384D4096S3xTx	14 Bit	x	Safe position (1x integer32), safe speed, preset (module not useable in Distributed Safety)
TRTxx-xxx 16384D4096S3xTx-unsafe	14 Bit	x	Position (1x integer32), speed (module not useable in Distributed Safety)

4.2.5 Setting the network data

Select the encoder in the Device view to show the properties of the PROFINET interface of the TRT/S3.

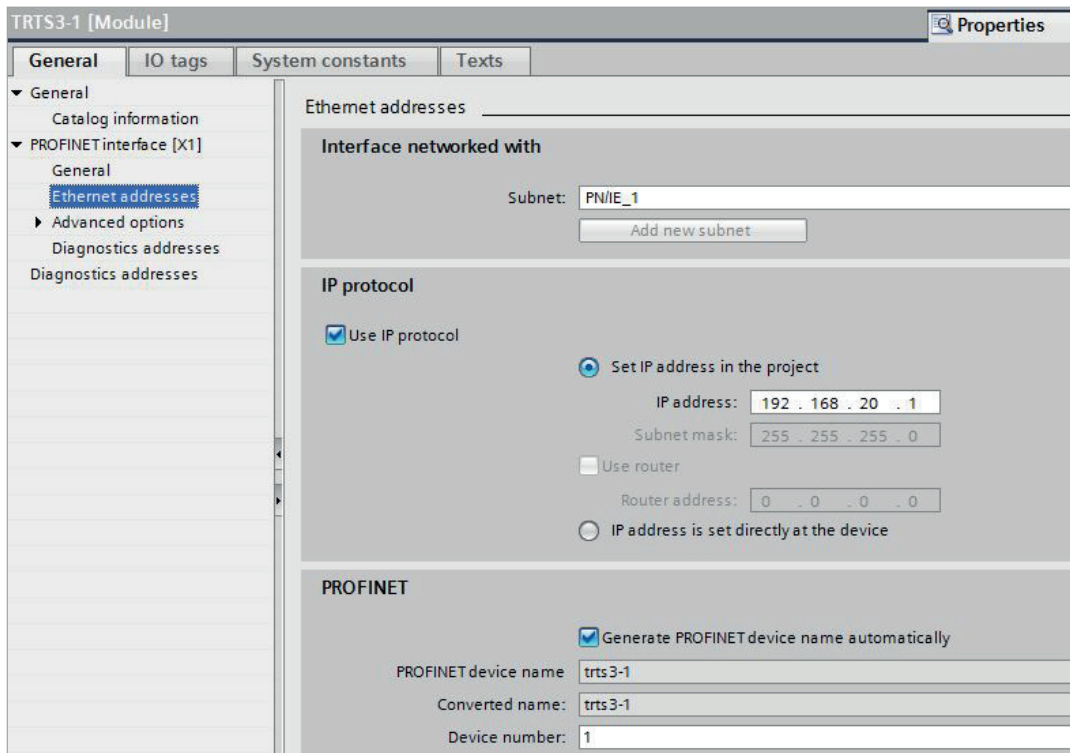

Fig.: 23

4.2.5.1 Setting the PROFINET / PROFIsafe Adresse

Under "General" enter the **PROFINET name** which must be unique throughout the network to identify the device. If **Generate PROFINET device name automatically** is selected the name which is entered under **PROFINET interface - General** will be registered here. The default name is TRTS3-1.

In the TRT/S3, the **Profisafe address** must be added to the name. To do this, attach a number between 1 and 65,535 to the end (a special separator between the Profinet name and Profisafe address is not necessary). This must then be entered for F_Dest_Add under the F parameters (see [Chapter 4.2.6.3](#)).

The name assigned here must either be manually allocated to the absolute encoder (see [Chapter 4.2.8](#)) or it can be assigned automatically by the controller using the topology editor (see [Chapter 4.2.7](#) Planning of "Device exchange without programming device" and "Automatic commissioning").

Project planning with Simatic Step7, Advanced Safety - TIA Portal

The device name is stored in the absolute encoder, where it is protected against zero voltage. An installed device can be exchanged with a brand new device without a programming device or exchanging a memory card. The correct name is automatically assigned to the new absolute encoder by the controller. To do this, however, the prerequisites under [Chapter 4.2.7](#) have to be met.

4.2.5.2 IP-Adresse

Under "PROFINET interface - Ethernet addresses - IP protocol" the boxes **Use IP protocol** and **Set IP address in the project** should be checked. Step7 automatically assigns an IP address when inserting the device in the project. Manually setting of the IP address is also possible.

4.2.5.3 Prioritized startup, media redundancy, update time and synchronisation

Via the interface option **Prioritized startup** the startup time of the TRT/S3 from power on until PROFINET I/O data exchange can be reduced from approx. 10s to 5s. However, this can only be achieved as of the second startup.

The TRT/S3 can be used as member (client) in a redundant ring. In case of a line topology one network cable from the last client to the controller (manager) is necessary only to achieve a redundant communication. Before setting the **media redundancy role** of the TRT/S3 a MRP domain has to be created and the MRP manager (normally the controller) to be assigned.

Under "PROFINET interface", "Advanced options", "Real time settings" the desired **Update time** of the TRT/S3 can be set. The possible values depend on the setting of the send clock of the CPU. The minimal update time for the TRT/S3 is 250 µs.

The desired real time class can be set under **Synchronisation**. The TRT/S3 supports the classes RT and IRT.

4.2.6 Setting the absolute encoder (properties of the module)

4.2.6.1 Setting the I/O address

After switching to the device view of the TRT/S3 and selecting slot 1 in the device overview the properties of the module can be accessed.

Set the PLC addresses for the input data (position, speed and status word) and for the output data (preset and control word) under I/O addresses (see [Chapter 5](#) for the data format).

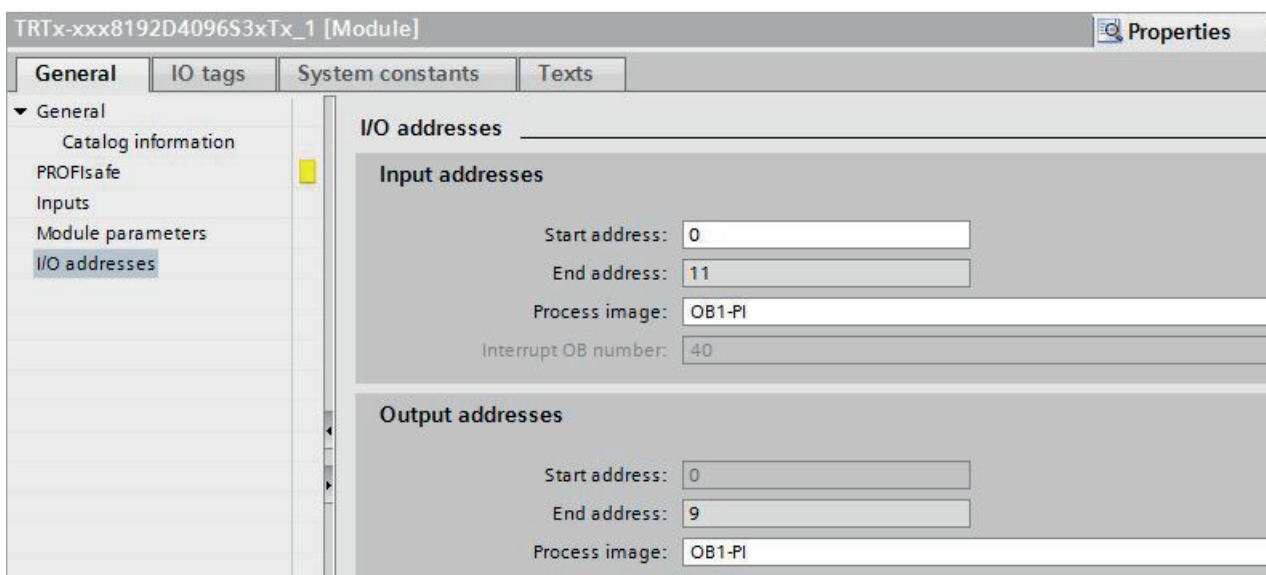

Fig.: 24

Project planning with Simatic Step7, Advanced Safety - TIA Portal

4.2.6.2 Parameterising the absolute encoder

The absolute encoder's parameters can be changed in the "Module parameters" tab. An explanation of the parameters can be found in [Chapter 6](#). After changing the encoder parameters the checksum has to be re-calculated and entered under the F-parameters (see next chapter).

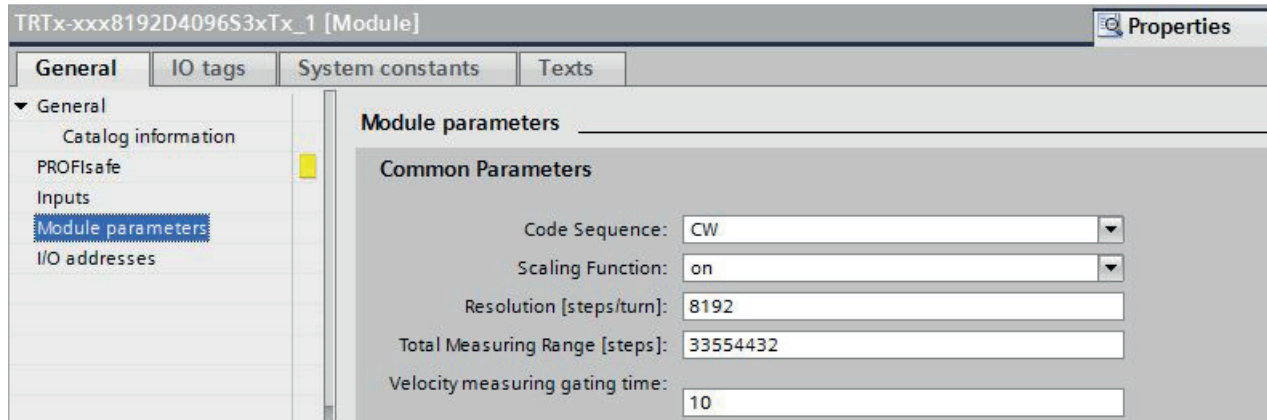

Fig.: 25

4.2.6.3 Setting the F parameters

The F parameters must be set in the "PROFIsafe" tab. Here, you have to set the Profisafe address attached to the Profinet name under "F_Dest_Add" and to specify a watchdog time corresponding to your system under "F_WD_Time" or you to take over the automatic setting. "F_Source_Add" is assigned automatically by the S7

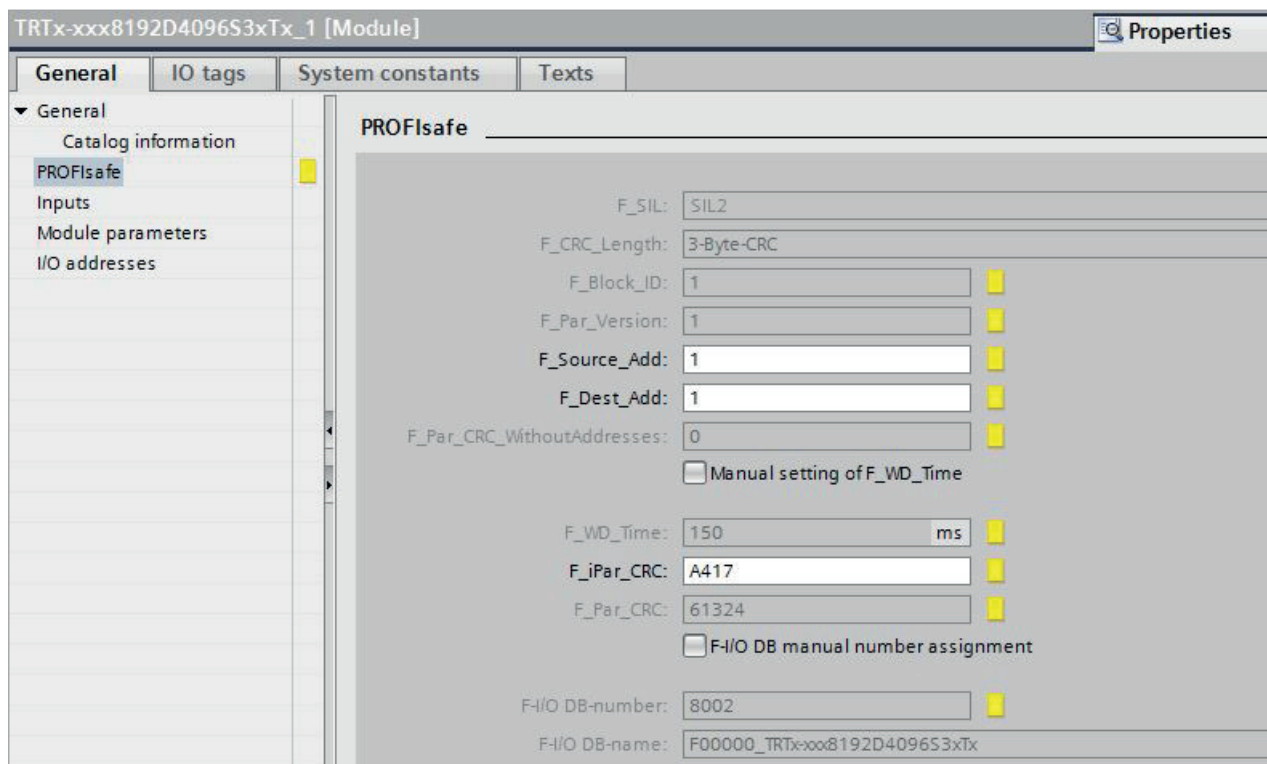

Fig.: 26

At the bottom of this window you can see the number and the symbolic name of the F-I/O data block of this encoder assigned by Step7.

Project planning with Simatic Step7, Advanced Safety - TIA Portal

Once you have changed the rotary encoder parameters, the checksum must be recalculated using these so-called i parameters and must be entered under "F_iPar_CRC". TWK provides you with the PsCRC programme for calculating the F_iPar_CRC (see Fig. 27).

It can be downloaded from the internet under www.twk.de topic **Documentation** model **PsCRC**.

An explanation of all F parameters can be found in [Chapter 6.2](#).

Fig.: 27

4.2.7 Planning of "Device exchange without programming device" and "Automatic commissioning"

If system restarting without the assignment of a new device name or the IP address is to be possible following the exchange of an installed absolute encoder with a mint condition device, this must be taken into consideration during project planning. This also applies to "Automatic commissioning", in which the manual and, in the case of larger projects, time-consuming assignment of the device name (as described in [Chapter 4.2.8](#)) is avoided during commissioning.

The following prerequisites have to be met:

- The controller and the devices must support the function "Device exchange without interchangeable medium or programming device" (for the latter, at least the device itself and its neighbouring devices). The TRT/S3 supports this function.
- The function "Device exchange without interchangeable medium" must be activated in the controller. This is the default setting.
- The devices must be in delivery condition, i.e. they must not yet possess any device name.

Now call the topology editor using the PROFINET system's context menu and define all PROFINET connections between the subscribers.

If the project is now loaded into the control system and the actual structure corresponds to the planned topology, all subscribers receive their planned names from the controller and device exchange succeeds without the reassignment of the device name.

4.2.8 Assignment of the device name

If a PROFINET topology has not been defined as described in [Chapter 4.2.7](#) or if the prerequisites for automatic commissioning are not met, the absolute encoder name must be assigned manually. With the absolute encoder connected and the programming device connected to the control system, select "Assign device name" in the context menu of the PROFINET.

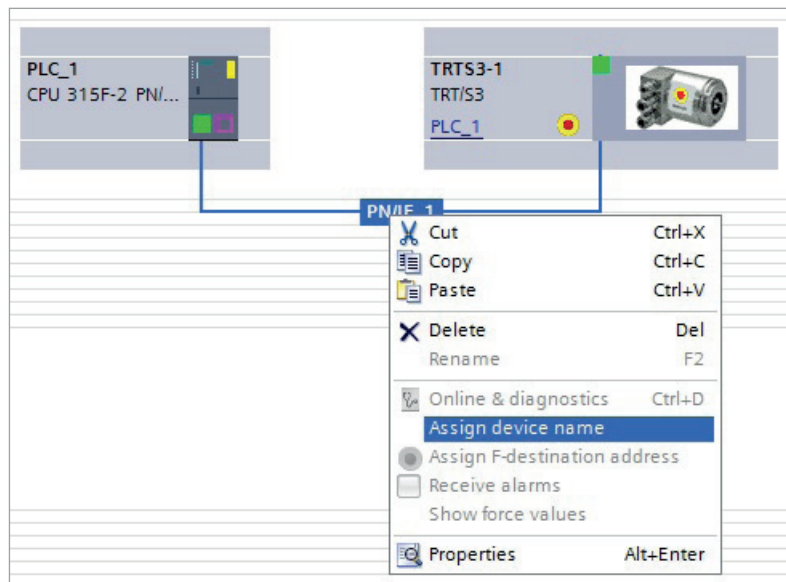

Fig.: 28

Subsequently the window "Assign PROFINET device name" appears. After selecting the correct online connection the accessible devices will be displayed. This for example could look like shown in figure 29.

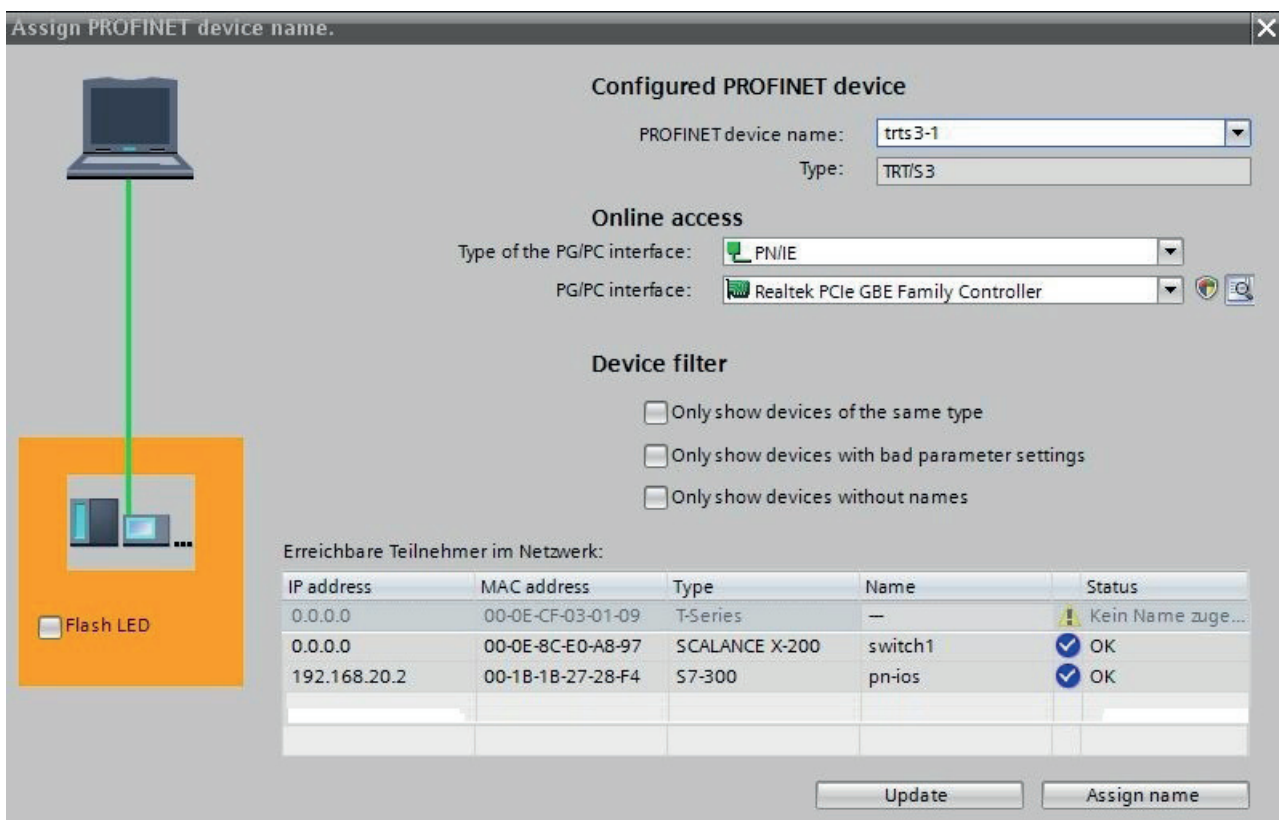

Fig.: 29

Project planning with Simatic Step7, Advanced Safety - TIA Portal

It can be seen that the absolute encoder device type "TWK T series" does not possess either a valid IP address or a name. Now mark the absolute encoder, check the name proposed at the top of the window and click on "assign name."

The device name is then stored in the absolute encoder, where it is protected against zero voltage.

The absolute encoder now logs onto the controller with its device name and is then provided with a valid IP address by the controller. This is also stored in the absolute encoder, where it is protected against zero voltage.

4.2.9 Resetting to the factory settings

After going online the online diagnosis is available via the context menu of the TRT/S3. Under "Functions" the function "Reset to factory settings" is available.

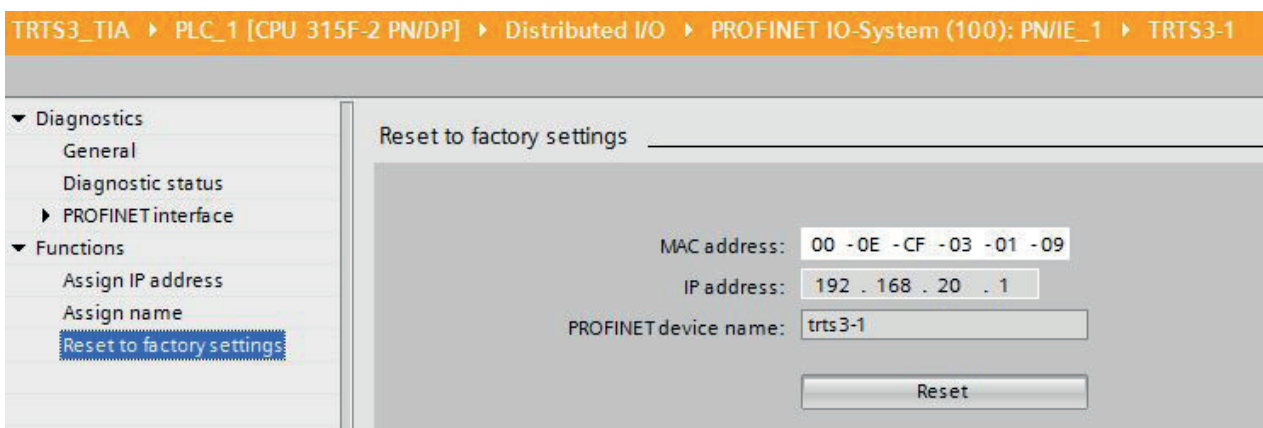

Fig.: 30

The following encoder data will be reset as follows:

The following are reset	Delivery condition
Device name	Empty
IP-parameters	All 0
I&M0-revision counter	0

After resetting, the connection to the profinet controller is closed and the NS LED lights up red. After switching the voltage off/on, the connection can be re-established by assigning the device name.

If the connections have been defined using the topology editor, the TRT/S3 restarts automatically with the name assigned during project planning.

Project planning with Simatic Step7

4.3 Application program

4.3.1 Remarks

For a detailed documentation for project planning and programming of F programs refer to SIMATIC S7 Distributed Safety - Project Planning and Programming, Programming and Operating Manual (A5E00109536-03) /7/ and SIMATIC S7 Distributed Safety Getting Started /8/ respectively SIMATIC Safety - Project Planning and Programming /9/ und SIMATIC Safety Getting Started /10/ when using Safety Advance in the TIA-Portal.

4.3.2 F-Peripherie-DB

On translation of the hardware configuration, an **F periphery DB** is generated for the absolute encoder, as for each other Profisafe subscriber. The automatically generated name consists of the I/O address and the module name.

The F periphery DB contains the for the operation of the encoder necessary variables. It has the following appearance: (A detailed description can be found in the documentation mentioned above)

Distributed Safety

Adresse	Deklaration	Name	Typ	Anfangswert	Kommentar
0.0	in	PASS_ON	BOOL	FALSE	1=ACTIVATE PASSIVATION
0.1	in	ACK_NEC	BOOL	TRUE	1=ACKNOWLEDGEMENT NECESSARY
0.2	in	ACK_REI	BOOL	FALSE	1=ACKNOWLEDGEMENT FOR REINTEGRATION
0.3	in	IPAR_EN	BOOL	FALSE	1=ENABLE I-PARAMETER ASSIGNMENT
2.0	out	PASS_OUT	BOOL	TRUE	1=PASSIVATION OUTPUT
2.1	out	QBAD	BOOL	TRUE	1=FAIL-SAFE VALUES ARE OUTPUT
2.2	out	ACK_REQ	BOOL	FALSE	1=ACKNOWLEDGEMENT REQUEST
2.3	out	IPAR_OK	BOOL	FALSE	1=NEW I-PARAMETER VALUES ASSIGNED
3.0	out	DIAG	BYTE	E#16#0	DIAGNOSTIC INFORMATION
4.0	out	QBAD_I_00	BOOL	TRUE	1=FAIL-SAFE VALUE IS OUTPUT AT INPUT CHANNEL
4.1	out	QBAD_I_01	BOOL	TRUE	1=FAIL-SAFE VALUE IS OUTPUT AT INPUT CHANNEL

Safety Advance

F00000_TRTx-xxx8192D4096S3xTx								
	Name	Data type	Offset	Start value	Retain	Visible in ...	Setpoint	Comment
1	▼ Input				<input type="checkbox"/>	<input type="checkbox"/>	<input type="checkbox"/>	
2	■ PASS_ON	Bool	0.0	false	<input type="checkbox"/>	<input checked="" type="checkbox"/>	<input type="checkbox"/>	1=ACTIVATE PASSIVATION
3	■ ACK_NEC	Bool	0.1	TRUE	<input type="checkbox"/>	<input checked="" type="checkbox"/>	<input type="checkbox"/>	1=ACKNOWLEDGEMENT NECESSARY
4	■ ACK_REI	Bool	0.2	false	<input type="checkbox"/>	<input checked="" type="checkbox"/>	<input type="checkbox"/>	1=ACKNOWLEDGEMENT FOR REINTEGRATION
5	■ IPAR_EN	Bool	0.3	false	<input type="checkbox"/>	<input checked="" type="checkbox"/>	<input type="checkbox"/>	1=ENABLE I-PARAMETER ASSIGNMENT
6	▼ Output				<input type="checkbox"/>	<input type="checkbox"/>	<input type="checkbox"/>	
7	■ PASS_OUT	Bool	2.0	TRUE	<input type="checkbox"/>	<input checked="" type="checkbox"/>	<input type="checkbox"/>	1=PASSIVATION OUTPUT
8	■ QBAD	Bool	2.1	TRUE	<input type="checkbox"/>	<input checked="" type="checkbox"/>	<input type="checkbox"/>	1=FAIL-SAFE VALUES ARE OUTPUT
9	■ ACK_REQ	Bool	2.2	false	<input type="checkbox"/>	<input checked="" type="checkbox"/>	<input type="checkbox"/>	1=ACKNOWLEDGEMENT REQUEST
10	■ IPAR_OK	Bool	2.3	false	<input type="checkbox"/>	<input checked="" type="checkbox"/>	<input type="checkbox"/>	1=NEW I-PARAMETER VALUES ASSIGNED
11	■ DIAG	Byte	3.0	16#0	<input type="checkbox"/>	<input checked="" type="checkbox"/>	<input type="checkbox"/>	DIAGNOSTIC INFORMATION

4.3.3 Accessing the encoder in the F program

Important for the fail safe operation of the encoder are: reintegration after communication or F periphery errors by the variables „ACK_REQ“ and "ACK_REI" or "ACK_GL", evaluation of the failsafe status by the variable "QBAD" and the evaluation of the diagnostic data by the variable "DIAG". All mentioned variables are provided by the F periphery DB. An example can be found in the following example program.

The access to the I/O data of the encoder is different and depending on the output code of the encoder and on

Project planning with Simatic Step7

the S7 software package. Because in **Distributed Safety** the use of double words in the safety program is prohibited in this case, only word access to the 32 bit position and reference value is possible, that means the position and the reference value are divided into 2 words each and the evaluation has to be done separately. For this use encoder with output code "R" and "W" are provided.

In the safety program of **TIA Safety Advanced** doublewords can be used now. Thus position and reference value in data type DINT32 can be treated in the same way as in the standard program. For this use encoder with output code "D" are provided. For a description of the data format see [chapter 5](#).

4.3.4 Example program

The following example shows how to access the position and speed value as well as the F periphery DB of the Profisafe absolute encoder in the safety programme. Setting a preset value and reading the diagnosis data is also demonstrated.

Only the programming steps which refer to the TWK absolute encoder are shown here. Knowledge regarding the programming and sequence of the failsafe S7 programme is assumed. As an introduction to failsafe programming, we recommend „SIMATIC S7 Distributed Safety - Getting Started“ /8/ and „SIMATIC S7 Distributed Safety – Project Planning and Programming“ /7/ respectively SIMATIC Safety - Project Planning and Programming /9/ and SIMATIC Safety Getting Started /10/ when using Safety Advance under TIA-Portal.

All program blocks of the following example can be found in the internet under www.twk.de. The following documentation was created with TIA Portal V15 incl. Safety Advance and a CPU115F-1PN.

Devices required to operate the example program

- F CPU with PROFINET interface
- Profisafe encoder TRT/S3 with output code "D" (see "remarks to the program" on the next page)
- Step7 as of V5.4 + S7 distributed safety as of version V5.4 or Step7 Professional V13 with Safety Advanced

Hardware structure of the example program

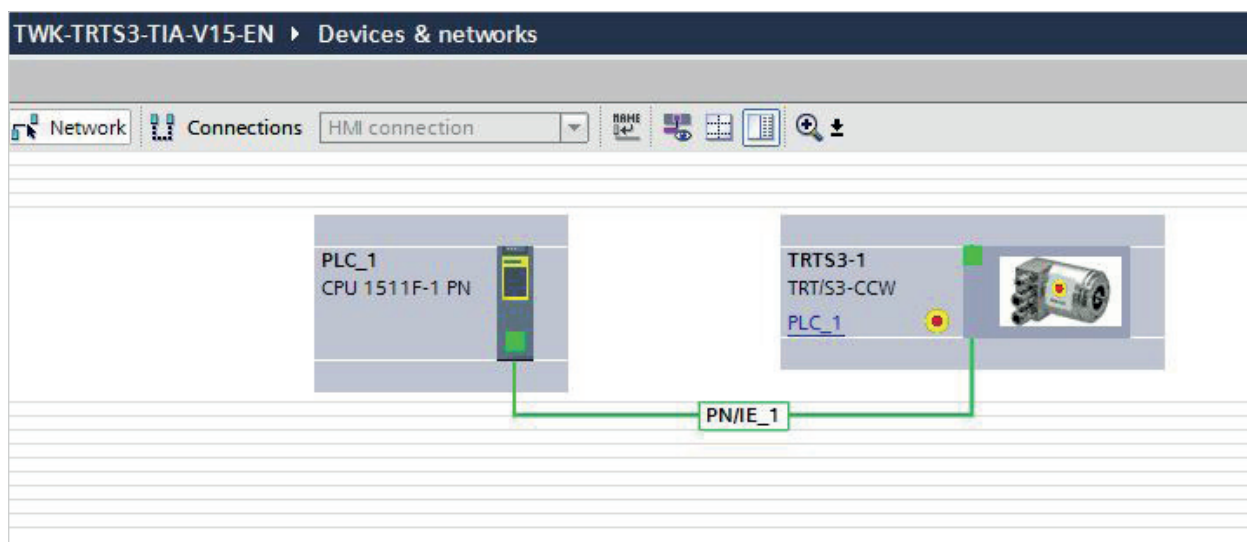

Project planning with Simatic Step7

Inputs and outputs used in the program

TWK-TRTS3-TIA-V15-EN ▶ PLC_1 [CPU 1511F-1 PN] ▶ PLC tags ▶ Standard-Variablen-tabelle [76]

Standard-Variablen-tabelle

	Name	Data type	Address ▲	Retain	Acces...	Writa...	Visibl...	Supervis...
1	TRT_ErrorPreset	Bool	%I1.0	<input type="checkbox"/>	<input checked="" type="checkbox"/>	<input checked="" type="checkbox"/>	<input checked="" type="checkbox"/>	
2	TRT_SpeedValue	Int	%IW2	<input type="checkbox"/>	<input checked="" type="checkbox"/>	<input checked="" type="checkbox"/>	<input checked="" type="checkbox"/>	
3	TRT_PositionsValue	Dint	%ID4	<input type="checkbox"/>	<input checked="" type="checkbox"/>	<input checked="" type="checkbox"/>	<input checked="" type="checkbox"/>	
4	Set_Preset	Bool	%Q1.0	<input type="checkbox"/>	<input checked="" type="checkbox"/>	<input checked="" type="checkbox"/>	<input checked="" type="checkbox"/>	
5	TRT_PresetValue	Dint	%QD2	<input type="checkbox"/>	<input checked="" type="checkbox"/>	<input checked="" type="checkbox"/>	<input checked="" type="checkbox"/>	
6	TrueFlag	Bool	%M0.0	<input type="checkbox"/>	<input checked="" type="checkbox"/>	<input checked="" type="checkbox"/>	<input checked="" type="checkbox"/>	
7	failsafestatus	Bool	%M0.1	<input type="checkbox"/>	<input checked="" type="checkbox"/>	<input checked="" type="checkbox"/>	<input checked="" type="checkbox"/>	
8	AckRequest	Bool	%M0.2	<input type="checkbox"/>	<input checked="" type="checkbox"/>	<input checked="" type="checkbox"/>	<input checked="" type="checkbox"/>	
9	Set_Preset_Pin	Bool	%M0.3	<input type="checkbox"/>	<input checked="" type="checkbox"/>	<input checked="" type="checkbox"/>	<input checked="" type="checkbox"/>	
10	Parameter_Enable	Bool	%M0.4	<input type="checkbox"/>	<input checked="" type="checkbox"/>	<input checked="" type="checkbox"/>	<input checked="" type="checkbox"/>	
11	UsrAck	Bool	%M0.5	<input type="checkbox"/>	<input checked="" type="checkbox"/>	<input checked="" type="checkbox"/>	<input checked="" type="checkbox"/>	
12	Limit1	Bool	%M0.6	<input type="checkbox"/>	<input checked="" type="checkbox"/>	<input checked="" type="checkbox"/>	<input checked="" type="checkbox"/>	
13	Diagnose_Request	Bool	%M11.0	<input type="checkbox"/>	<input checked="" type="checkbox"/>	<input checked="" type="checkbox"/>	<input checked="" type="checkbox"/>	
14	DataValid	Bool	%M11.1	<input type="checkbox"/>	<input checked="" type="checkbox"/>	<input checked="" type="checkbox"/>	<input checked="" type="checkbox"/>	
15	Busy	Bool	%M11.2	<input type="checkbox"/>	<input checked="" type="checkbox"/>	<input checked="" type="checkbox"/>	<input checked="" type="checkbox"/>	
16	Error	Bool	%M11.3	<input type="checkbox"/>	<input checked="" type="checkbox"/>	<input checked="" type="checkbox"/>	<input checked="" type="checkbox"/>	
17	LaddrValue	Hw_Any	%MW12	<input type="checkbox"/>	<input checked="" type="checkbox"/>	<input checked="" type="checkbox"/>	<input checked="" type="checkbox"/>	
18	PresetValue	Dint	%MD100	<input type="checkbox"/>	<input checked="" type="checkbox"/>	<input checked="" type="checkbox"/>	<input checked="" type="checkbox"/>	
19	Sensor_PresetValue	Dint	%MD104	<input type="checkbox"/>	<input checked="" type="checkbox"/>	<input checked="" type="checkbox"/>	<input checked="" type="checkbox"/>	
20	Speed_Data	Int	%MW108	<input type="checkbox"/>	<input checked="" type="checkbox"/>	<input checked="" type="checkbox"/>	<input checked="" type="checkbox"/>	

Remarks to the program

Access to the profisafe absolute encoder is carried out in a F programme module (here FB100), which must be called up in a F-runtime group (F call-up module F CALL when using Distributed Safety). Calling the FB100 in the F CALL is not described here.

When using Distributed Safety it should be noted that access to double words is not permitted (see [chapter 4.3.3](#)). An example program for Distributed Safety is available on our homepage. The examples show how to carry out the comparison between the position and the threshold values although the position value consists of two words and the compare operation needs integer values.

The following listing contains only the for the handling of the encoder relevant part. Program blocks like F-CALL, clock OBs or peripheral data blocks are not listed.

Project planning with Simatic Step7

OB1, NW 1 - 3: Load preset value, show F error messages with the DIAG byte

▼ **Block title:** Main program for TWK-PROFIsafe encoder TRT/S3

▼ TrueFlag, DIAG-Byte and calling FB ReadDiagData. Calling up the safety program is done in the F runtime group.

▼ **Network 1:**

Generate true flag

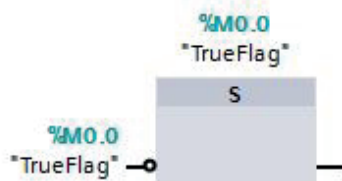

▼ **Network 2:**

The preset value is stored in the MD104.

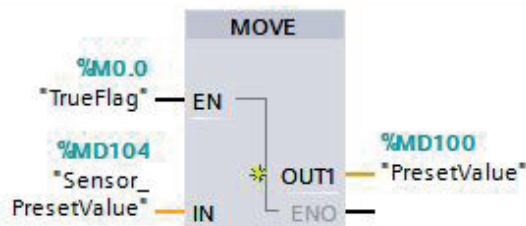

▼ **Network 3:**

▼ Display of F error messages (here in help byte 1; in a real system, this should be further processed in the error message system). Polling the DIAG variable in the safety programme is not permissible. (Meaning of the individual bits in I7f)



Project planning with Simatic Step7

FB100, NW 1 - 3: Reading QBAD and Acknowledge

▼ **Block title:** TWK absolute encoder as a PROFISAFE subscriber

Comment

▼ **Network 1:**

- ▼ Polling of the failsafe status of the absolute encoder. In a real system this bit must be polled to introduce the fail safe state of the system. In case of QBAD = 1 the system has to go in the fail safe state.

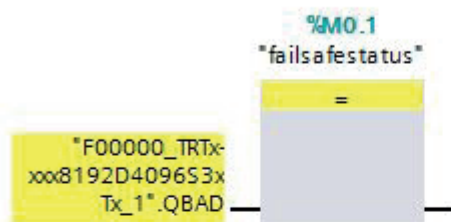

▼ **Network 2:**

Display necessary user acknowledgement

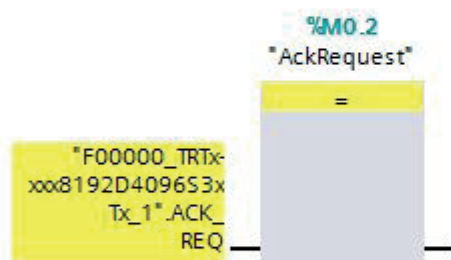

▼ **Network 3:**

Carry out user acknowledgement

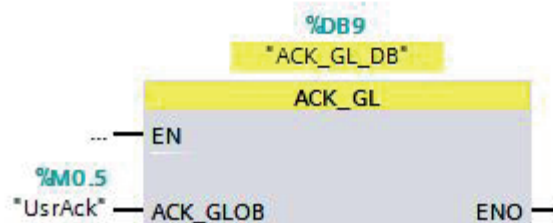

Project planning with Simatic Step7

FB100, NW 4 - 6: Set reference value

Network 4: 1=ENABLE I-PARAMETER ASSIGNMENT

Enabling the preset setting via iPar_EN

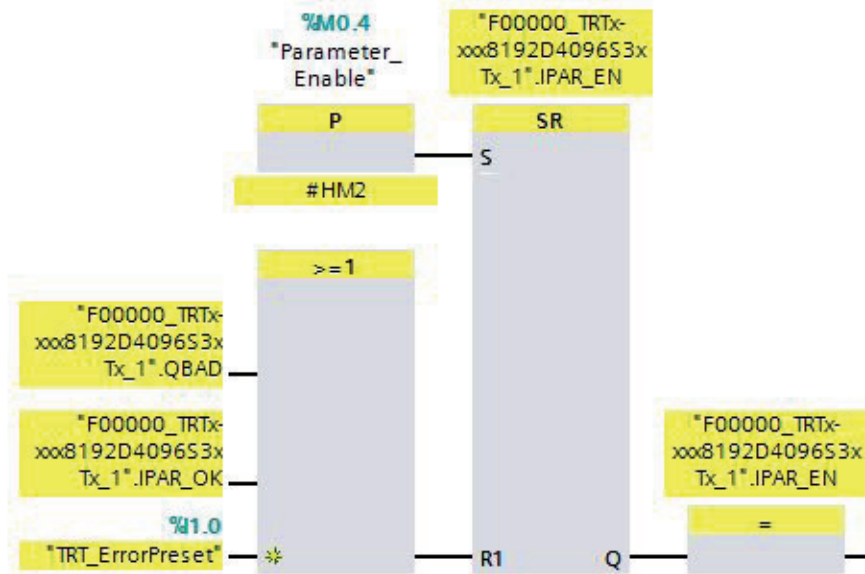

Network 5:

Set preset bit



Network 6:

Write preset value to output double word



Project planning with Simatic Step7

FB100, NW 7 - 8: Accessing position and velocity

▼ **Network 7:**

Example of a limit monitoring of the position value

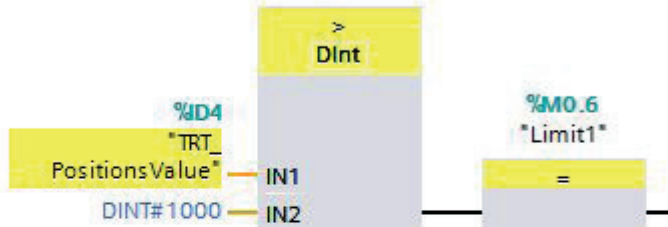

▼ **Network 8:**

Accessing the speed value



Project planning with Simatic Step7

Reading the diagnosis data

On occurrence of a PROFINET device diagnostic alarm, OB 82 is run through in S7. Amongst other aspects, the trigger for the diagnostic alarm can be ascertained in this. The diagnostic data can then be read-out with SFB52 which has to be called in the cyclic program. The events which trigger a diagnostic alarm in the absolute encoder can be found in [Chapter 7.2](#).

The control system transfers the hardware identifier of the device which has transmitted the diagnostic alarm in the local variable LADDR.

OB 82: Evaluation of the local OB 82 data and initialisation of the read job

▼ **Block title:** "I/O Point Fault"

▼ The system will jump to the OB82 as soon as a modul or device requests diagnostic or sends an alarm.

▼ **Network 1:** Conversion into integer format

Comment

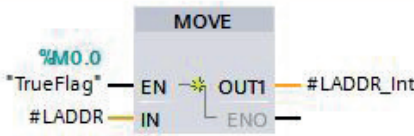

▼ **Network 2:** Set diagnostic request

Comparing with the Hardware Identifier

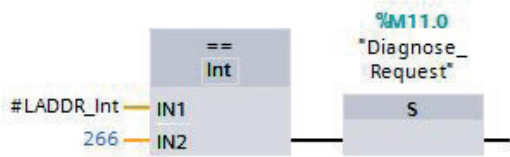

▼ **Network 3:**

Store the hardware identifier in a global variable



OB 1, NW 4: Calling the FB 1 to read the diagnostic data

▼ **Network 4:** Calling FB2

Reading diagnostic data with the SFB52

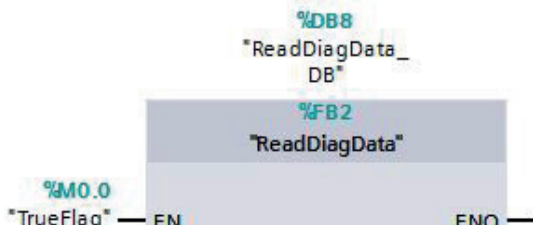

Project planning with Simatic Step7

FB 2: Reading the diagnostic data with the SFB52 RDREC

▼ **Block title:** Read diagnostic data

The data will be written to the DB101 starting with byte 0.

▼ **Network 1:** Calling SFB52 (RDREC)

▼ ID = Record Index

FDE9 hex - Encoder diagnostic data 63 byte (DB101), BF01 hex - Parameter data 11 byte (DB102)

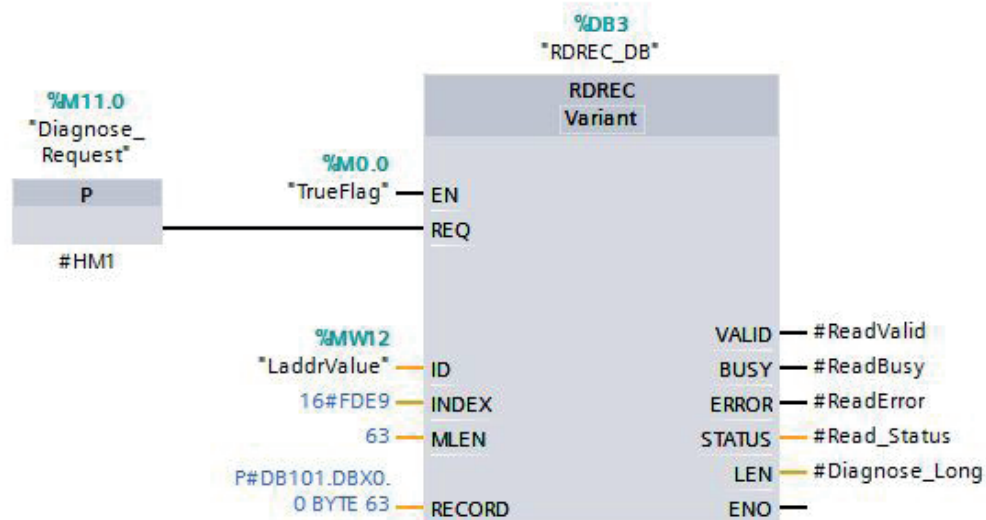

▼ **Network 2:** Data Valid

Shows if the last read was successful and if the data are valid.

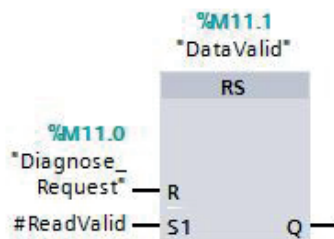

▼ **Network 3:** Busy

Shows if the last reading was initiated.

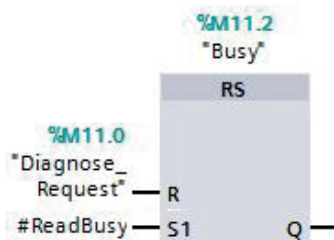

Project planning with Simatic Step7

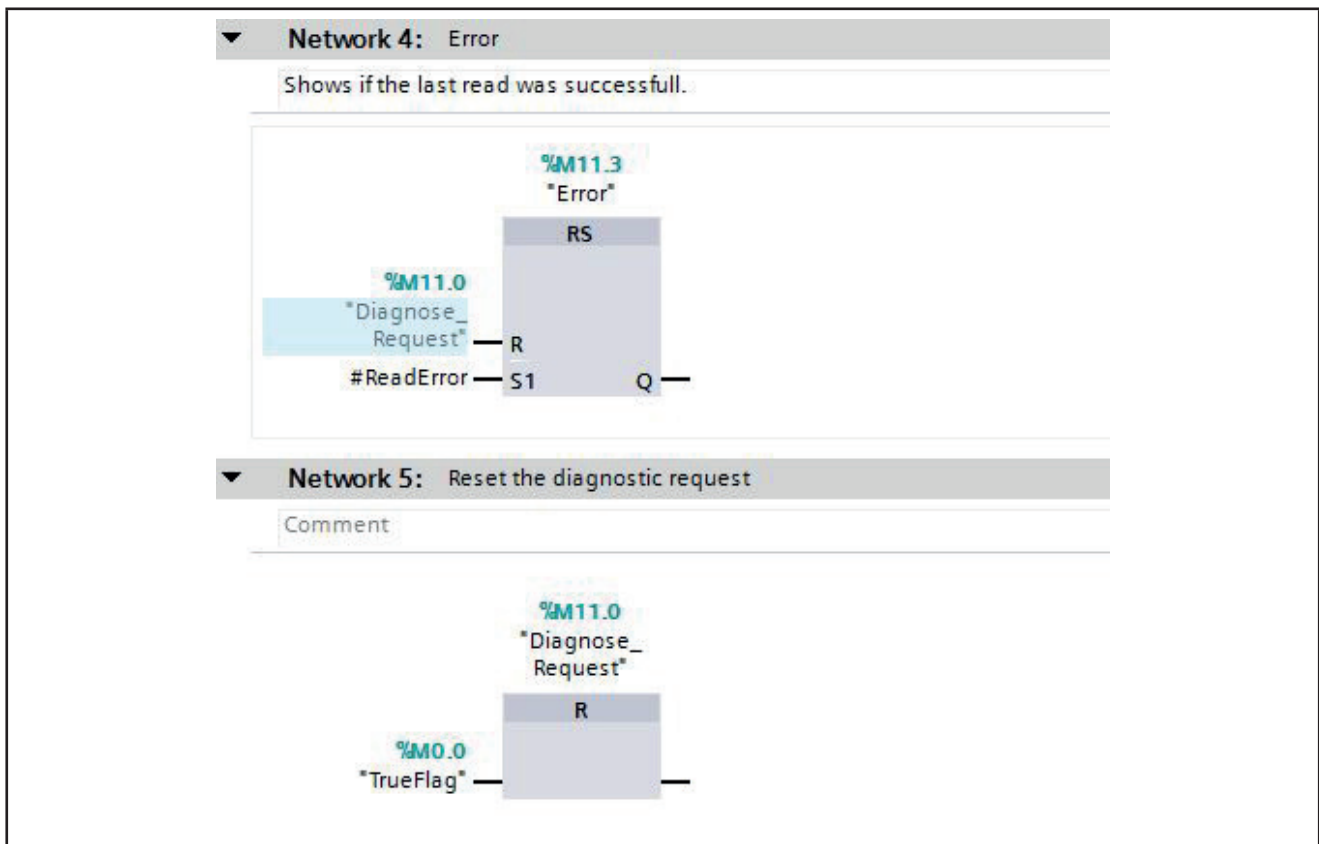

Evaluation of a Profinet alarm

The SFB54 (RALRM) has to be called in an alarm OB. In the output ID it delivers the hardware identifier of the device that has triggered the alarm. In the data block to which AINFO points amongst others the alarm number can be read.

OB 82: NW 4

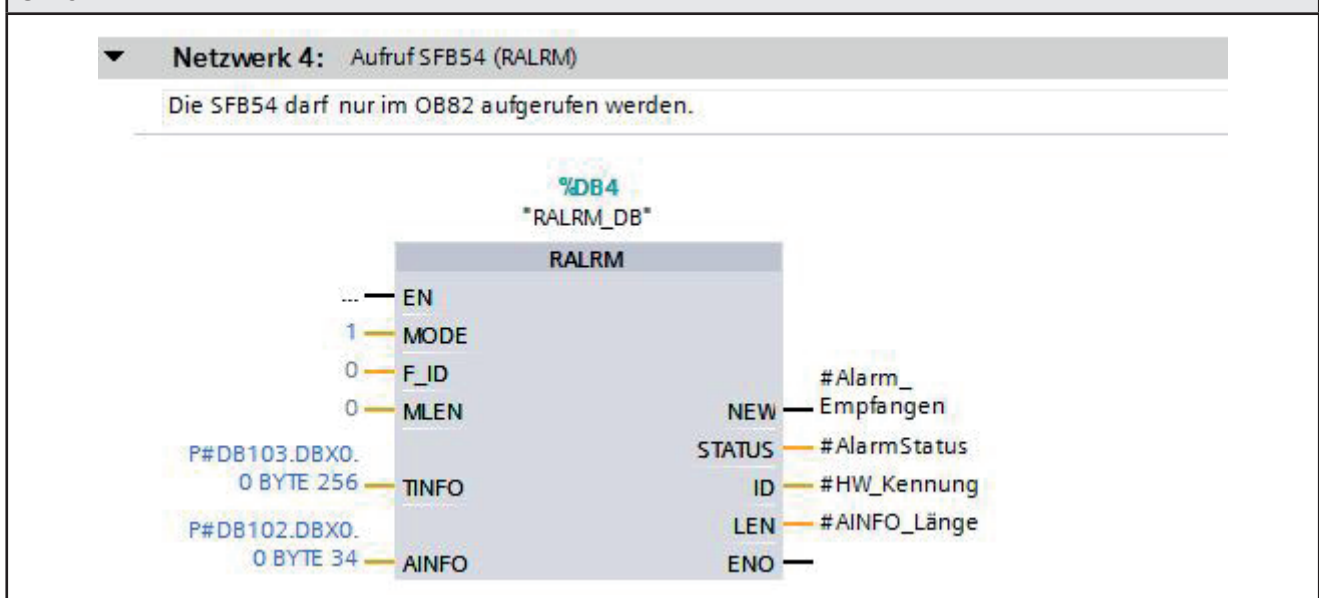

I/O data

5. I/O data

5.1 Overview

5.1.1 Output code R and W

Input data: Device -> Controller

Octet 1	Octet 2	Octet 3	Octet 4	Octet 5	Octet 6	Octet 7	Octet 8	Octet 9	Octet 10	Octet 11	Octet 12
status word		position data				velocity		F input data			

Output data: Controller -> Device

Octet 1	Octet 2	Octet 3	Octet 4	Octet 5	Octet 6	Octet 7	Octet 8	Octet 9	Octet 10
control word		preset value				F output data			

5.1.2 Output code D

Input data: Device -> Controller

Octet 1	Octet 2	Octet 3	Octet 4	Octet 5	Octet 6	Octet 7	Octet 8	Octet 9	Octet 10	Octet 11	Octet 12
status word		velocity		position data				F input data			

Output data: Controller -> Device

Octet 1	Octet 2	Octet 3	Octet 4	Octet 5	Octet 6	Octet 7	Octet 8	Octet 9	Octet 10
control word		preset value				F output data			

5.2 Status word

The status word contains error bits which can be interpreted by the application program of the PLC.

Octet 1								Octet 2							
7	6	5	4	3	2	1	0	7	6	5	4	3	2	1	0
15	14	13	12	11	10	9	8	7	6	5	4	3	2	1	0
16 bit status word															

Bit	Name	Remarks/remedy
0	Error_Preset	Error during preset setting - the preset value has to be in the range of 0 ... total number of steps -1 - set the preset value only during standstill of the shaft - switch on scaling
1 - 15	not used	

5.3 Position data

The position value is output as a 2x 16 bit signed integer (output code R and W) or 1x 32 bit signed integer value (output code D) in Motorola format (Big Endian). The factory setting of the resolution of the position value is 4096 respectively 8192 steps / turn. When using devices with output code R and D it can be adjusted via the parameterization. For output code W it is fixed to the maximum value.

I/O data

5.3.1 Data format coding R

Octet 3								Octet 4								Octet 5								Octet 6							
7	6	5	4	3	2	1	0	7	6	5	4	3	2	1	0	7	6	5	4	3	2	1	0	7	6	5	4	3	2	1	0
31	30	29	28	27	26	25	24	23	22	21	20	19	18	17	16	15	14	13	12	11	10	9	8	7	6	5	4	3	2	1	0
0	0	0	0	0	0	0	0	0	0	0	0	0	0	0	0	0	0	0	0	position value* (singleturn)											
0	0	0	0	0	0	0	0	position value* (high)								position value (low)															

* At 12 bit resolution. With higher resolution correspondingly longer.

5.3.2. Data format coding W

The rotary encoders with code type W (TRTxx-xxxxxxxW4096S3xTxx) reveal deviating position and preset value representation. In these models, the number of revolutions (multiturn part) is output in the first word and the steps of the single-turn part in the second word

Octet 3								Octet 4								Octet 5								Octet 6							
7	6	5	4	3	2	1	0	7	6	5	4	3	2	1	0	7	6	5	4	3	2	1	0	7	6	5	4	3	2	1	0
31	30	29	28	27	26	25	24	23	22	21	20	19	18	17	16	15	14	13	12	11	10	9	8	7	6	5	4	3	2	1	0
0	0	0	0	number of turns								0	0	0	0	steps*															

* At 12 bit resolution. With higher resolution correspondingly longer.

5.3.3 Data format coding D

Encoder with the output code D (TRTxx-xxxxxxxD4096S3xTxx) provide a position- und preset representation as double word (Integer32).

Octet 5								Octet 6								Octet 7								Octet 8							
7	6	5	4	3	2	1	0	7	6	5	4	3	2	1	0	7	6	5	4	3	2	1	0	7	6	5	4	3	2	1	0
31	30	29	28	27	26	25	24	23	22	21	20	19	18	17	16	15	14	13	12	11	10	9	8	7	6	5	4	3	2	1	0
0	0	0	0	0	0	0	0	0	0	0	0	0	0	0	0	0	0	0	0	position value* (singleturn)											
0	0	0	0	0	0	0	0	position value* (multiturn)																							

* At 12 bit resolution. With higher resolution correspondingly longer.

5.4 Velocity

The velocity value is determined via the cyclically read-in of the position data. The dimension is steps per gating time. The gating time (time interval for determining the change of position) is adjustable in the range of 10 - 1000 ms. The default value is 10 ms.

Coding R, W	Octet 7								Octet 8							
Coding D	Octet 3								Octet 4							
	7	6	5	4	3	2	1	0	7	6	5	4	3	2	1	0
	15	14	13	12	11	10	9	8	7	6	5	4	3	2	1	0
	16 bit velocity															

The speed value is output as a 16-bit signed integer value in Motorola format (Big-Endian). The following applies

I/O data

to the prefix:

positive for	increasing position
negative for	decreasing position

The refresh rate of the velocity signal is independent from the selected gating time always 1ms.

The speed measurement resolution is independent of the resolution set for the position value (resolution parameter). In devices with 12 or 13 bit resolution it is based on a resolution of 4096 otherwise on 65536 steps per revolution.

The steps/gating time unit can be converted to rpm as follows:

$$u = \frac{v \times 60000 / t}{r}$$

v = encoder output for speed value
 t = gating time in ms
 u = speed in rpm
 r = resolution in steps (4096 or 65536)

5.5 F input data

The 4-byte F input data consist of the 1-byte F status and the 3-byte CRC checksum. Their content is defined in the Profisafe profile /1/. The status of the F status bit must be evaluated in the F application programme (see programme example in [Chapter 4.3.4](#)).

5.6 Control word

Octet 7								Octet 8							
7	6	5	4	3	2	1	0	7	6	5	4	3	2	1	0
15	14	13	12	11	10	9	8	7	6	5	4	3	2	1	0
16 bit control word															

Bit	Name	Meaning
0	Set_Preset	The preset value is activated on the rising edge.
1 - 15	not used	

5.7 Preset value (reference value)

In certain cases, setting the reference value is unavoidable in order to compare the machine position values and the absolute position of the absolute encoder. The reference value is the position value which is displayed at the reference point. The user must note that the reference value must lie within the range of 0 to (total number of steps - 1). This particularly has to be taken into consideration when changing the total number of steps.

The set reference value (preset value) function can only be executed whilst the absolute encoder shaft is stationary! Setting the reference value is only possible when scaling is switched on (see [Chapter 6](#))!

The preset value is set in the cyclical I/O data traffic by transferring the preset value in the output bytes (octets 3 - 6) and subsequently (or simultaneously) setting bit 0 of the control word (octets 1 - 2).

Before setting the preset value, the i parameterization must be enabled with the F control bit **iPar_EN**. The rotary encoder reports the completion of the process with the F status bit **iPar_OK**. If an error occurs on setting the preset value, e.g. due to a rotating rotary encoder shaft, this is reported via status bit 0 in the status word. In both cases, i.e. in the case of successful preset and in the event of an error, the iPar_EN bit must be reset. The rotary encoder then resets its iPAR_OK to zero. (See programme example in [Chapter 4.3.4](#).)

I/O data

The preset value is taken over with the rising edge of bit 0 of the control word. An offset value is calculated (from the current actual position and the reference value) by the absolute encoder in this case. This is stored in the absolute encoder, where it is protected against zero voltage, with the result that the new position is correctly output again even following voltage failure.

5.7.1 Data format coding R

Octet 3								Octet 4								Octet 5								Octet 6							
7	6	5	4	3	2	1	0	7	6	5	4	3	2	1	0	7	6	5	4	3	2	1	0	7	6	5	4	3	2	1	0
31	30	29	28	27	26	25	24	23	22	21	20	19	18	17	16	15	14	13	12	11	10	9	8	7	6	5	4	3	2	1	0
0	0	0	0	0	0	0	0	0	0	0	0	0	0	0	0	0	0	0	0	preset value* (Singleturn)											
0	0	0	0	0	0	0	0	preset value*								preset value															

* At 12 bit resolution. With higher resolution correspondingly longer.

5.7.2. Data format coding W

Octet 3								Octet 4								Octet 5								Octet 6							
7	6	5	4	3	2	1	0	7	6	5	4	3	2	1	0	7	6	5	4	3	2	1	0	7	6	5	4	3	2	1	0
31	30	29	28	27	26	25	24	23	22	21	20	19	18	17	16	15	14	13	12	11	10	9	8	7	6	5	4	3	2	1	0
0	0	0	0	preset value number of turns				0	0	0	0	preset value steps*																			

* At 12 bit resolution. With higher resolution correspondingly longer.

5.7.3 Data format coding D

Octet 3								Octet 4								Octet 5								Octet 6							
7	6	5	4	3	2	1	0	7	6	5	4	3	2	1	0	7	6	5	4	3	2	1	0	7	6	5	4	3	2	1	0
31	30	29	28	27	26	25	24	23	22	21	20	19	18	17	16	15	14	13	12	11	10	9	8	7	6	5	4	3	2	1	0
0	0	0	0	0	0	0	0	0	0	0	0	0	0	0	0	0	0	0	0	preset value* (Singleturn)											
0	0	0	0	0	0	0	0	preset value*																							

* At 12 bit resolution. With higher resolution correspondingly longer.

5.8 F output data

The 4-byte F output data consist of 1 control byte and the 3-byte CRC checksum. Their content is defined in the Profisafe profile /1/. The F control bits are made available by the F control system and must be implemented in the F application program (see programme example [Chapter 4.3.4](#)).

Parameterisation

6. Parameterisation

Parameterisation of the absolute encoder is carried out using the acyclical PROFINET services. In the case of the Simatic S7 control system, this is carried out during starting as default. Changing the parameter of the TRT/S3 during cyclic I/O data exchange is not possible.

Attention: Never change the parameterisation whilst a system or machine is in operation! A complete function test has to be performed after each parameter change before returning to normal operation.

Record index	Data
0xBF02	Encoder parameter
0x64	F parameter

6.1 Encoder parameter

6.1.1 Overview

Byte	Data type	Designation	Default
1	BYTE	Operating mode	0x08
2 - 5	UINT32	Single turn resolution [steps/turn]	4096*
6 - 9	UINT32	Total measuring steps [steps]	16.777.216 or 4096* for Singleturn
10 - 11	INT16	Gating time [ms]	10

* HW version 2: 16384

** HW version 2: 67.108.864

6.1.2 Description of the absolute encoder parameters

Byte	Bit No.	Parameter	Value range	Default	Remark
1	0	Code path	0: clockwise (cw) 1: counter clockwise (ccw)	clockwise (cw)	Ascending values on rotation clockwise (CW) or counter clockwise (CCW). (When looking towards the shaft)
	1-2	Not used			
	3	Scaling function	0: off 1: on	on	Enables/disables scaling of the position value via the resolution, the total number of steps and the preset.
	4-7	Not used			
2 - 5		Resolution [steps/revolution]	1 - 4096*	4096*	To change this, the parameter "Scaling function" must be set to "on"
6 - 9		Total number of steps [steps]	1 - 16,777,216* or 4096* for Singleturn	16,777,216*	To change this, the parameter "Scaling function" must be set to "on"
10 - 11		Gating time [ms]	10 - 1000	10	

The maximum values depend on the encoder type. The values specified here apply to an encoder with 12 bit resolution.

Parameterisation

Notes:

Coding:

All values in Motorola format (Big Endian)

Resolution

The resolution of encoders with **coding W** is not changeable and factory set to 4096 respectively 8192 for the 25 bit encoder.

Total number of steps:

It must be noted that the number of revolutions is calculated in powers of 2ⁿ internally in the encoder. Irrespective of this requirement, the user can programme the desired total number of steps and the desired resolution according to the application. During calculation, the absolute encoder uses the next highest power of 2ⁿ if necessary. In this case, the values are designated as the effective resolution or the effective total number of steps and are displayed as the output values.

Example :	Desired total number of steps:	20,480
	Desired resolution:	4096
	Desired number of revolutions:	5
	Internal absolute encoder calculation	
	Effective total number of steps:	32,768
	Effective resolution:	4096
	Calculated number of revolutions:	8

(Note: The above notice is to be taken into consideration in the case of non-reversible operation. In the listed example, position 0 is only reached after 32,767 steps and not after 20,479 steps as desired.)

Checksum:

After changing the encoder parameters, the checksum must be recalculated and entered under the F-parameter "F_iPar_CRC". TWK provides the program PsCRC for calculating the F_iPar_CRC. You can download this program from the Internet at www.twk.de, **Documentation** area, **PsCRC**.

6.2 F parameter

6.2.1 Overview

Overview			
Octet	Data type	Description	Default
1	Unsigned8	F_Prm_Flag1	
2	Unsigned8	F_Prm_Flag2	
3-4	Unsigned16	F_Source_Add	0
5-6	Unsigned16	F_Dest_Add	1
7-8	Unsigned16	F_WD_Time	120
9-12	Unsigned32	F_iPar_CRC	7100
13-14	Unsigned16	F_Par_CRC	-----

Parameterisation

6.2.2 Description of the F parameters

Octet 1: F_Prm_Flag1				
Bit no.	Parameter name	Value range	Default	Remarks
0	F_Check_SeqNr	0: NoCheck	NoCheck	Fixed to "No Check"
1	F_Check_iPar	0: NoCheck	NoCheck	Fixed to "No Check"
2-3	F_SIL	1: SIL2	SIL2	Fixed to "SIL2"
4-5	F_CRC_Length	0: 3-Byte-CRC (V2 Mode)	3-Byte-CRC	Checksum of the process data (CRC2).
6-7	not used			

Octet 2: F_Prm_Flag2				
Bit no.	Parameter name	Value range	Default	Remarks
0-2	not used			
3-5	F_Block_ID	0 - 7	1	1 = F parameter block contains F_iPar_CRC
6-7	F_Par_Version	1: V2-Mode	1	Parameter version

Octet 3-14				
Octet	Parameter name	Value range	Default	Remarks
3-4	F_Source_Add	1 - 65534		Automatically assigned by the SIMATIC manager
5-6	F_Dest_Add	1 - 65535	1	Must correspond to the Profisafe address set in the Profinet name. The TRT/S3 is a F device with PROFIsafe address type 1, i.e. the F_Dest_Add has be unique netwide and CPU-wide.
7-8	F_WD_Time	1 - 65534	120	Monitoring time in the failsafe slave. Within the monitoring time, a valid, current safety message must be received from the F CPU. Otherwise, the device goes to the safe state. Set the monitoring time long enough to ensure not only that the communication functions tolerate telegram delays, but also that the fault response is triggered quickly enough if a fault occurs (e.g. interruption of the communication connection). The minimum watchdog time for the TRT/S3 is 120 ms (for 4 ms actualisation time).
9-12	F_iPar_CRC	1 - 0xFFFF FFFF	0x1BBC	CRC checksum on the iParameters (encoder parameters). A checksum calculation program is available for download on www.twk.de menu documentaton.
13-14	F_ParCRC (CRC1)	0 - 65535		CRC checksum on the F parameters. Is generated from the SIMATIC Manager.

Diagnostic

7. Diagnostic

7.1 Overview

The encoder TRT/S3 provides diagnostic data in 3 different ways.

- LEDs (see [Chapter 3.3](#))
- PROFINET alarms (see [Chapter 7.2](#))
- Diagnostic data (see [Chapter 7.3](#))

7.2 PROFINET alarms

The following alarms are sent via the PROFINET alarm mechanism. In the PROFINET controller they are displayed in plain text and partially with a help text.

Error no. (hex)	Error text	Reaction	Status-LED (NS)	Remarks/remedy
0x001A	Internal communication error (TPS-1)	Input and F data = 0		Please switch power off/on or change the device
0x0040	Mismatch of safety destination address (F_Dest_Add)	Diagnostic data: F parameter error	red flashing (1 Hz)	
0x0041	Safety destination address not valid (F_Dest_Add)	Diagnostic data: F parameter error	red flashing (1 Hz)	
0x0042	Safety source address not valid (F_Source_Add)	Diagnostic data: F parameter error	red flashing (1 Hz)	
0x0043	Safety watchdog time value is 0 ms (F_WD_Time)	Diagnostic data: F parameter error	red flashing (1 Hz)	
0x0044	Parameter "F_SIL" exceeds SIL from specific device application	Diagnostic data: F parameter error	red flashing (1 Hz)	
0x0045	Parameter "F_CRC_Length" does not match the generated values	Diagnostic data: F parameter error	red flashing (1 Hz)	
0x0046	Version of F-Parameter set incorrect (F_Par_Version)	Diagnostic data: F parameter error	red flashing (1 Hz)	
0x0047	F parameter CRC error (CRC1-Fault)	Diagnostic data: F parameter error	red flashing (1 Hz)	
0x0048	Error in F parameterset	Diagnostic data: F parameter error	red flashing (1 Hz)	
0x004B	Inconsistent iParameters (iPar-CRC error)	Diagnostic data: F parameter error	red flashing (1 Hz)	Please check the value of the F parameter F-iPar-CRC.
0x1100	Device error	Diagnostic data: device error F status word: FV_activated, Device_Fault	fast red flashing (10 Hz)	Please switch power off/on or change the device.

Diagnostic

0x1110	Preset error	Diagnostic data: Preset error Status word: Error-Preset	red flashing (1 Hz)	The preset value has to be in the range of 0 ... total number of steps -1. Setting the preset is only allowed when the shaft is in standstill. Scaling has to be on.
0x1120	Velocity measuring range exceeded	Diagnostic data: velocity error F status word: FV_activated	red flashing (1 Hz)	Please reduce the velocity or decrease the gating time.
0x1140	Parameter error	Diagnostic data: Parameter error	red flashing (1 Hz)	The value for the total measuring range has to be in the range of: resolution ... (resolution x max. number of turns (4096)).
0x1150	Supply voltage out of range	F status word: FV_activated, Device_Fault	red flashing (1 Hz)	Please check the supply voltage and switch power supply off/on.
0x1160	Wrong Record Index on startup	F status word: FV_activated, Device_Fault	red flashing (1 Hz)	Please check your GSD file.
0x1170	Sensor not ready	F status word: FV_activated, Device_Fault	red flashing (1 Hz)	Please switch power off/on or change the device.

7.3 Diagnostic data records

The following diagnostic records are available in the TRT/S3. They can be read out with the PROFINET acyclic read services.

Record index	Data
0xAFF0	I&M0 data (according to I&M-specification version 1.2 /9/)
0xBF02	Parameter data (see Chapter 6)
0xFDE9	Diagnostic data according to Encoder Class 2 Profile (see below)

7.3.1 Diagnostic data according to Encoder Class 2 Profile

Diagnosis data in data record 0xFDE9					
Byte	Datatype	Diagnostic function	Default (values in hex)	Diagnostic alarm	Remark
1 - 8	BYTE	Reserved	00		
9	BYTE	Operating status	08	No	CW, Scaling on
10	BYTE	Encoder typ	01	No	Absolute multiturn encoder

*Depending on the encoder type.

Diagnostic

11 - 14	UINT32	Maximum resolution	0000.1000*	No	Maximum possible steps/revolution of the present encoder typ.
15 - 16	UINT16	Maximum measuring range	1000	No	4096 revolutions
17	UINT8	Additional alarm messages	00	No	Not supported
18 - 19	UINT16	Supported alarm messages	0000	No	Not supported
20 - 21	UINT16	Warning messages	0000	No	Not supported
22 - 23	UINT16	Supported warning messages	0000	No	Not supported
24 - 25	UINT16	Profile version	0101	No	Current encoder profile version
26 - 27	UINT16	Software version	xx.xx	No	Current firmware version
28 - 31	UINT32	Operating time	FFFF.FFFF	No	Not supported
32 - 35	UINT32	Offset value	0000.0000	No	Current internally calculated offset value
36 - 39	UINT32	Manufacturer offset value	0000.0000	No	Not supported
40 - 43	UINT32	Resolution	0000.1000*	No	Currently set resolution
44 - 47	UINT32	Total number of steps	01.000.0000*	No	Current total number of steps
48 - 57	BYTE	Serial number		No	Serial number of the device
58 - 59	BYTE	Reserved	0000	No	
60 - 63	BYTE	Manufacturer specific diagnostic data	00000000	Yes	See below

*Depending on the encoder type.

Encoder specific diagnostic data

Byte	Bit	Error message	Diagnostic alarm	Status-LED (NS)	Remarks/remedy (see Profinet alarms)
60		reserviert			
61		reserviert			
62	0	Flash error	yes	fast red flashing (10 Hz)	
	1	not used			
	2	F parameter error	yes	red flashing (1 Hz)	
	3 - 7	not used			
63	0	not used			
	1	Device error	yes	fast red flashing (10 Hz)	
	2	Parameter error	yes	red flashing (1 Hz)	
	3	Scaling error	yes	red flashing (1 Hz)	
	4	Supply voltage out of range	yes	red flashing (1 Hz)	
	5	not used			
	6	Preset error	yes	red flashing (1 Hz)	
	7	Velocity error	yes	red flashing (1 Hz)	

Scope of delivery, Literature

8. Scope of delivery

The scope of delivery includes:

- Absolute encoder with PROFIsafe interface
- Connection assignment TY XXXXX (depending on the device variant)

Available for download on www.twk.de are:

- the corresponding datasheet
- this user manual
- the checksum calculation program PsCrc
- the certificates
- example programmes
- GSD file and bitmap

9. Literature

- /1/ PROFIsafe-Profile for Safety Technology, Order No. 3.092 und 3.192, PROFIBUS Nutzerorganisation e. V., Haid-und-Neu-Str. 7, D-76131 Karlsruhe, www.profibus.com
- /2/ PROFINET - Interface nach IEC 61158 / 61784 bzw. PNO-Spezifikation, Order No. 2.712 und 2.722, PROFIBUS Nutzerorganisation e. V., Haid-und-Neu-Str. 7, D-76131 Karlsruhe, www.profibus.com
- /3/ PROFINET Installation guideline, Order No. 8.071, PROFIBUS Nutzerorganisation e. V., Haid-und-Neu-Str. 7, D-76131 Karlsruhe, www.profibus.com
- /4/ PROFINET Cabling and Interconnection Technology, Order No.: 2.252, PROFIBUS Nutzerorganisation e. V., Haid-und-Neu-Str. 7, D-76131 Karlsruhe, www.profibus.com
- /5/ Installation Guideline PROFINET Part2: Network Components, Order No.: 2.252 p2, PROFIBUS Nutzerorganisation e. V., Haid-und-Neu-Str. 7, D-76131 Karlsruhe, www.profibus.com
- /6/ PROFIsafe - Environmental Requirements related to PROFIsafe - Profile for Safety Technology on PROFIBUS DP and PROFINET IO (IEC 61784-3-3), Order No. 2.232, PROFIBUS Nutzerorganisation e. V., Haid-und-Neu-Str. 7, D-76131 Karlsruhe, www.profibus.com
- /7/ SIMATIC S7 Distributed Safety - Project Planning and Programming, Programming and Operating Manual (A5E00109536-03) - <http://support.automation.siemens.com>
- /8/ SIMATIC S7 Distributed Safety Getting Started (A5E00320725-01) - <http://support.automation.siemens.com>
- /9/ Profile Guidelines Part 1: Identification & Maintenance Functions, Order No. 3.502, www.profibus.com
- /10/ SIMATIC Safety - Project Planning and Programming (A5E02714440-AC) - <http://support.automation.siemens.com>
- /11/ SIMATIC Safety - Getting Started (A5E02714463-01) - <http://support.automation.siemens.com>